

Bandpass Filter

Schneider-Kreuznach magnetron sputtered industrial bandpass filters impress with steep slopes and high transmission at stable cut-on and cut-off wavelengths. The very flat surface makes them ideal for high end inspection systems.

Schneider-Kreuznach bandpass filters are RoHS conform. Custom sizes are available on request.

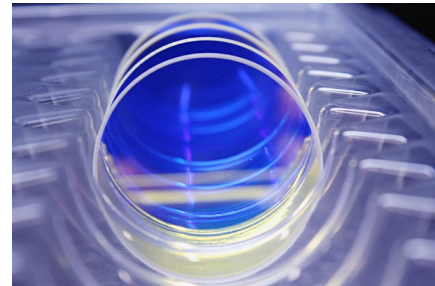

Key Features

- Ave. Transmittance 95 %
- Steep Slopes
- Wavelength Tolerance +/- 1 %
- Ultra Low Reflection
- Deep Blocking / High OD

Applications

- Automation
- 3D Measurement
- Food & Beverage Inspection
- Ophthalmology
- Microscopy
- Robotics

General technical specifications

according to ISO 10110

Parallelism	1'
Surface	19 – 30 mm: 5/3 x 0,10 L3 x 0,008 31 – 50 mm: 5/3 x 0,16 L3 x 0,008 51 – 64 mm: 5/4 x 0,16 L3 x 0,008
Wavefront distortion	19 – 30 mm: 13/1 (0.25) 19 – 30 mm: 13/1 (0.2) 31 – 50 mm: 13/1 (0.30) 31 – 50 mm: 13/1 (0.25) - 51 – 64 mm: 13/1 (0.35)
Thickness	1.0 +/- 0.08 mm 2.0 +/- 0.08 mm
Climate Testing	
Slow temperature cycling	DIN ISO 9022-2-14-03 -1
Damp heat, cyclic	DIN ISO 9022-2-16-01-1
Chemical resistant	DIN ISO 9011-4-04-05
Adhesive strength	DIN ISO 9211-4-02-03

Bandpass Filter BP 465-70 HT

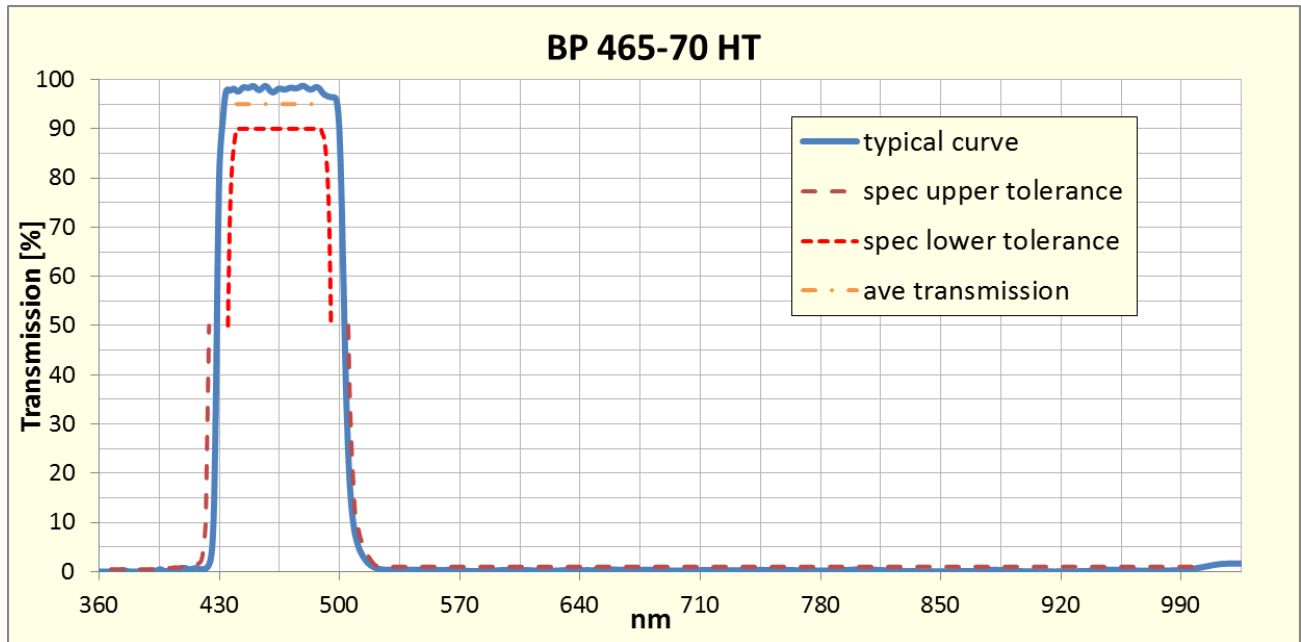

Technical specifications

according to ISO 10110

Angle of incident	0° +/- 8°
Wavelength range	430 +/- 5 nm to 500 +/- 5 nm
Transmittance	440 - 490 nm: Tave > 95%, Tmin > 90%
Blocking	UV - 390 nm: Tabs < 0.5% 530 - 1000 nm: Tave < 0.5%, Tmax < 1.0%
Coating	ULR

unmounted	filter glass	ID	ID	mounted	filter	ID
		[2 mm thickness]	[1 mm thickness]			
19 mm	IFG BP 465-70 HT 19,0 2-0001	1082450		CMT	IF BP 465-70 HT CMT	1082875
27 mm	IFG BP 465-70 HT 27,0 2-0001	1082451		SH 25.5	IF BP 465-70 HT SH 25.5	1084483
34 mm	IFG BP 465-70 HT 34,0 2-0001	1082452	1095261	SH 27.0	IF BP 465-70 HT SH 27.0	1085601
43 mm	IFG BP 465-70 HT 43,0 2-0001	1082453		SN1 30.5	IF BP 465-70 HT SN1 30.5	1082876
55 mm	IFG BP 465-70 HT 55,0 2-0001	1082454		SH 35.5	IF BP 465-70 HT SH 35.5	1085700
64 mm	IFG BP 465-70 HT 64,0 2-0001	1082455		SH 37.0	IF BP 465-70 HT SH 37.0	1085384
				SH 39.0	IF BP 465-70 HT SH 39.0	
				SH 40.5	IF BP 465-70 HT SH 40.5	1085701
				SH 43.0	IF BP 465-70 HT SH 43.0	1085702
				SH 46.0	IF BP 465-70 HT SH 46.0	
				SH 49.0	IF BP 465-70 HT SH 49.0	1089142
				SH 52.0	IF BP 465-70 HT SH 52.0	1088649
				SH 55.0	IF BP 465-70 HT SH 55.0	1089143
				SH 58.0	IF BP 465-70 HT SH 58.0	1084869
				SH 62.0	IF BP 465-70 HT SH 62.0	1086292
				SH 67.0	IF BP 465-70 HT SH 67.0	1084982

Bandpass Filter BP 490-180 HT

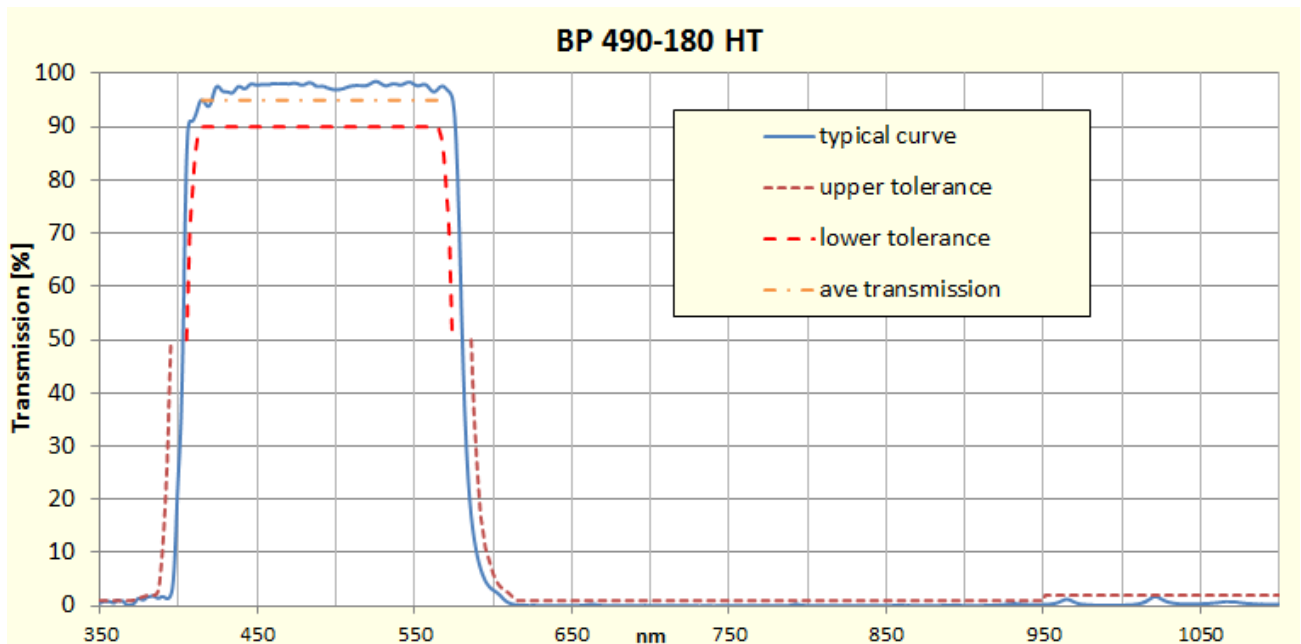

Technical specifications

according to ISO 10110

Angle of incident	0° +/- 8°
Wavelength range	400 +/- 5 nm to 580 +/- 6nm
Transmittance	415 – 565 nm: Tave > 95%, Tmin > 90%
Blocking	UV – 370 nm: T < 1.0% 615 – 950 nm: T < 1.0%, 915 – 1100 nm: T < 2.0%
Coating	ULR

unmounted	filter glass	ID	mounted	filter	ID
19 mm	IFG BP 490-180 HT 19,0 2-0001	1082250	CMT	IF BP 490-180 HT CMT	1085674
27 mm	IFG BP 490-180 HT 27,0 2-0001	1082251	SH 25.5	IF BP 490-180 HT SH 25.5	1089731
34 mm	IFG BP 490-180 HT 34,0 2-0001	1082552	SH 27.0	IF BP 490-180 HT SH 27.0	1089648
43 mm	IFG BP 490-180 HT 43,0 2-0001	1082553	SN1 30.5	IF BP 490-180 HT SN1 30.5	1085642
55 mm	IFG BP 490-180 HT 55,0 2-0001	1082554	SH 35.5	IF BP 490-180 HT SH 35.5	1089599
64 mm	IFG BP 490-180 HT 64,0 2-0001	1082555	SH 37.0	IF BP 490-180 HT SH 37.0	
			SH 39.0	IF BP 490-180 HT SH 39.0	
			SH 40.5	IF BP 490-180 HT SH 40.5	1090370
			SH 43.0	IF BP 490-180 HT SH 43.0	1090614
			SH 46.0	IF BP 490-180 HT SH 46.0	1086644
			SH 49.0	IF BP 490-180 HT SH 49.0	
			SH 52.0	IF BP 490-180 HT SH 52.0	1090159
			SH 55.0	IF BP 490-180 HT SH 55.0	
			SH 58.0	IF BP 490-180 HT SH 58.0	
			SH 62.0	IF BP 490-180 HT SH 62.0	
			SH 67.0	IF BP 490-180 HT SH 67.0	1088309

Bandpass Filter BP 540-80 HT

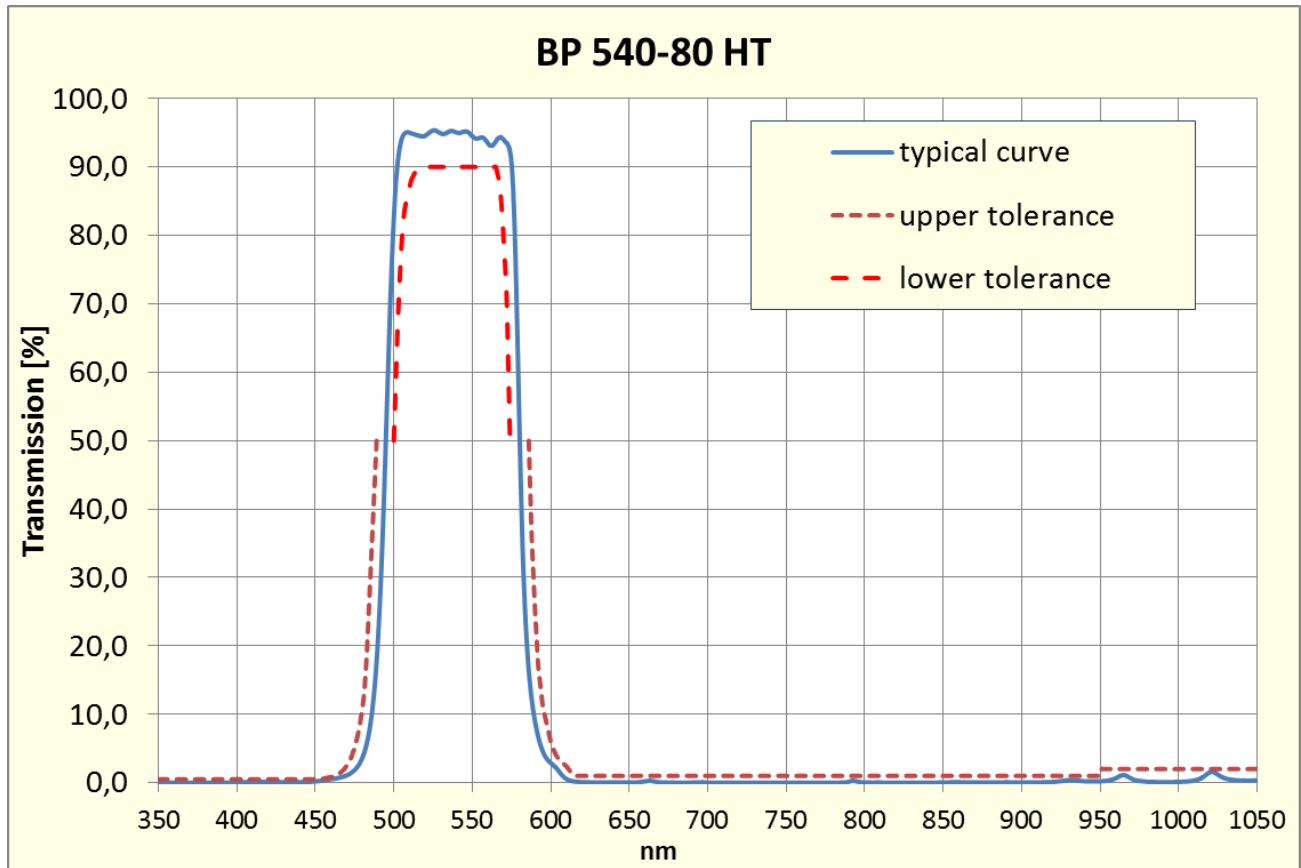

Technical specifications

according to ISO 10110

Angle of incident	0° +/- 8°
Wavelength range	495 +/- 5 nm to 580 +/- 6 nm
Transmittance	515 - 565 nm: T > 90%
Blocking	UV - 450 nm: T < 0.5% 615 - 950 nm: T < 1.5%, 950 - 1100 nm: T < 2.0%

unmounted	filter glass	ID	mounted	filter	ID
19 mm	IFG BP 540-80 HT 19,0 2-0001	1082570	CMT	IF BP 540-80 HT CMT	1084907
27 mm	IFG BP 540-80 HT 27,0 2-0001	1082571	SH 25.5	IF BP 540-80 HT SH 25.5	1085703
34 mm	IFG BP 540-80 HT 34,0 2-0001	1082572	SH 27.0	IF BP 540-80 HT SH 27.0	1085186
43 mm	IFG BP 540-80 HT 43,0 2-0001	1082573	SN1 30.5	IF BP 540-80 HT SN1 30.5	1085645
55 mm	IFG BP 540-80 HT 55,0 2-0001	1082574	SH 35.5	IF BP 540-80 HT SH 35.5	1088049
64 mm	IFG BP 540-80 HT 64,0 2-0001	1082575	SH 37.0	IF BP 540-80 HT SH 37.0	1085385
			SH 39.0	IF BP 540-80 HT SH 39.0	
			SH 40.5	IF BP 540-80 HT SH 40.5	1085704
			SH 43.0	IF BP 540-80 HT SH 43.0	1085705
			SH 46.0	IF BP 540-80 HT SH 46.0	1086645
			SH 49.0	IF BP 540-80 HT SH 49.0	
			SH 52.0	IF BP 540-80 HT SH 52.0	1085813
			SH 55.0	IF BP 540-80 HT SH 55.0	
			SH 58.0	IF BP 540-80 HT SH 58.0	1085706
			SH 62.0	IF BP 540-80 HT SH 62.0	
			SH 67.0	IF BP 540-80 HT SH 67.0	1085645

Bandpass Filter BP 575-170 HT

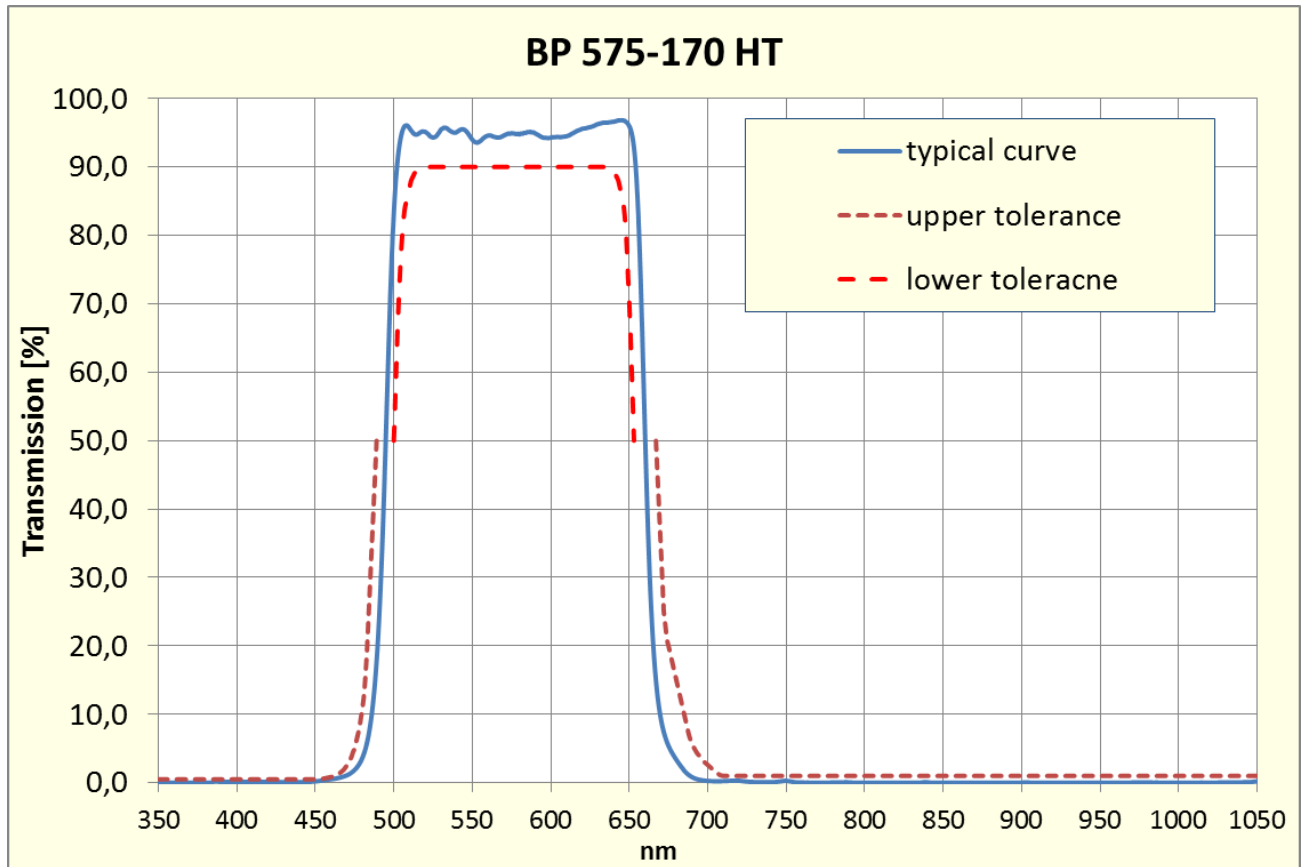

Technical specifications

according to ISO 10110

Angle of incident	0° +/- 8°
Wavelength range	495 +/- 5 nm to 660 +/- 7nm
Transmittance	515 - 640 nm: T > 90%
Blocking	UV - 390 nm: T < 0.5% 710 - 1050 nm: T < 1.0%

unmounted	filter glass	ID	mounted	filter	ID
19 mm	IFG BP 575-170 HT 19,0 2-0001	1082542	CMT	IF BP 575-170 HT CMT	1085678
27 mm	IFG BP 575-170 HT 27,0 2-0001	1082543	SH 25.5	IF BP 575-170 HT SH 25.5	1085451
34 mm	IFG BP 575-170 HT 34,0 2-0001	1082545	SH 27.0	IF BP 575-170 HT SH 27.0	
43 mm	IFG BP 575-170 HT 43,0 2-0001	1082546	SN1 30.5	IF BP 575-170 HT SN1 30.5	1085647
55 mm	IFG BP 575-170 HT 55,0 2-0001	1082547	SH 35.5	IF BP 575-170 HT SH 35.5	1088010
64 mm	IFG BP 575-170 HT 64,0 2-0001	1082548	SH 37.0	IF BP 575-170 HT SH 37.0	
			SH 39.0	IF BP 575-170 HT SH 39.0	
			SH 40.5	IF BP 575-170 HT SH 40.5	
			SH 43.0	IF BP 575-170 HT SH 43.0	
			SH 46.0	IF BP 575-170 HT SH 46.0	1086646
			SH 49.0	IF BP 575-170 HT SH 49.0	1086647
			SH 52.0	IF BP 575-170 HT SH 52.0	1091166
			SH 55.0	IF BP 575-170 HT SH 55.0	
			SH 58.0	IF BP 575-170 HT SH 58.0	
			SH 62.0	IF BP 575-170 HT SH 62.0	1094908
			SH 67.0	IF BP 575-170 HT SH 67.0	1085060

Bandpass Filter BP 590-50 HT

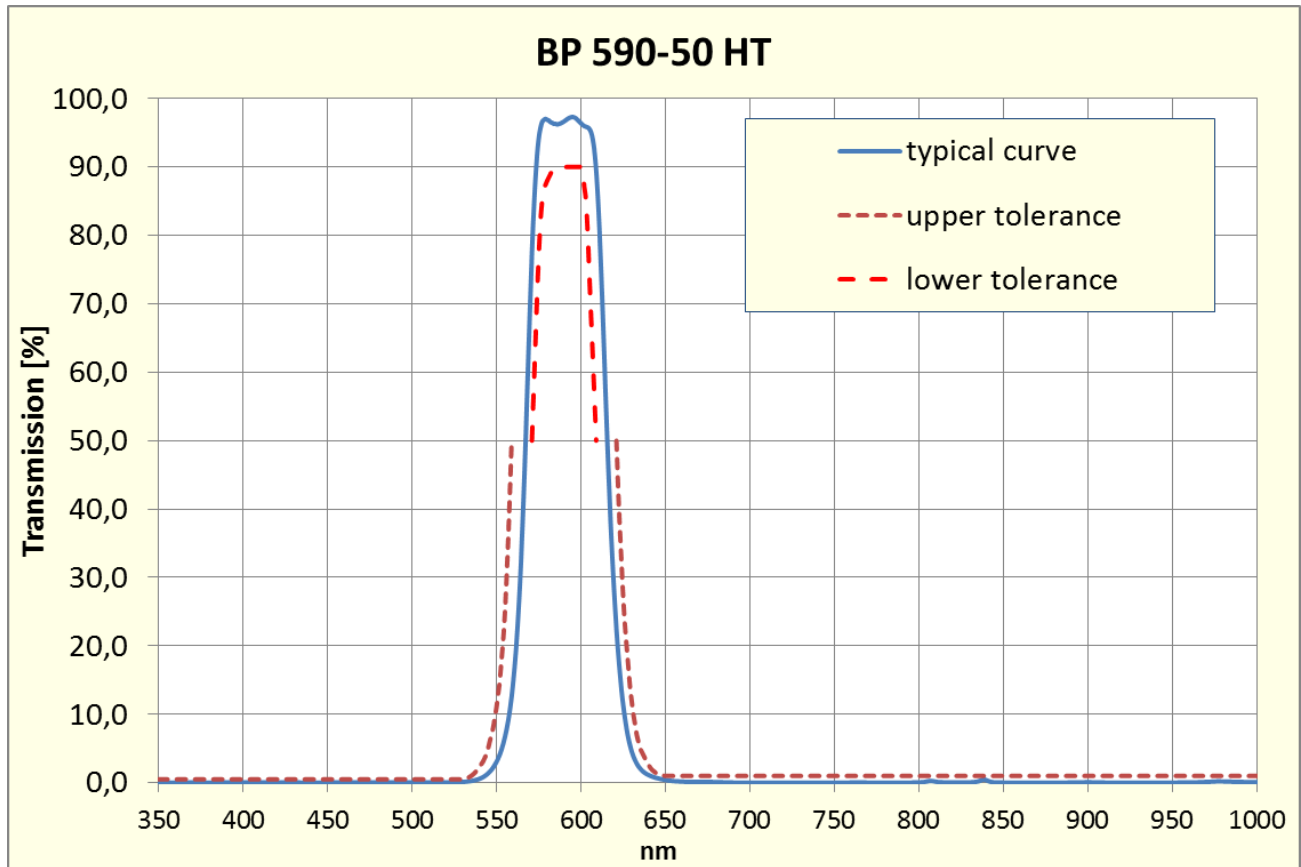

Technical specifications

according to ISO 10110

Angle of incident	0° +/- 8°
Wavelength range	565 +/- 6 nm to 615 +/- 6 nm
Transmittance	585 - 595 nm: T > 90%
Blocking	UV - 530 nm: T < 0.5% 650 - 1000 nm: T < 1.0%

unmounted	filter glass	ID	mounted	filter	ID
19 mm	IFG BP 590-50 HT 19,0 2-0001	1082577	CMT	IF BP 590-50 HT CMT	1084480
27 mm	IFG BP 590-50 HT 27,0 2-0001	1082578	SH 25.5	IF BP 590-50 HT SH 25.5	1089732
34 mm	IFG BP 590-50 HT 34,0 2-0001	1082579	SH 27.0	IF BP 590-50 HT SH 27.0	1088593
43 mm	IFG BP 590-50 HT 43,0 2-0001	1082580	SN1 30.5	IF BP 590-50 HT SN1 30.5	1085648
55 mm	IFG BP 590-50 HT 55,0 2-0001	1082581	SH 35.5	IF BP 590-50 HT SH 35.5	
64 mm	IFG BP 590-50 HT 64,0 2-0001	1082582	SH 37.0	IF BP 590-50 HT SH 37.0	
			SH 39.0	IF BP 590-50 HT SH 39.0	
			SH 40.5	IF BP 590-50 HT SH 40.5	1087907
			SH 43.0	IF BP 590-50 HT SH 43.0	1085531
			SH 46.0	IF BP 590-50 HT SH 46.0	1086648
			SH 49.0	IF BP 590-50 HT SH 49.0	
			SH 52.0	IF BP 590-50 HT SH 52.0	1090081
			SH 55.0	IF BP 590-50 HT SH 55.0	
			SH 58.0	IF BP 590-50 HT SH 58.0	
			SH 62.0	IF BP 590-50 HT SH 62.0	
			SH 67.0	IF BP 590-50 HT SH 67.0	1084984

Bandpass Filter BP 590-200 HT

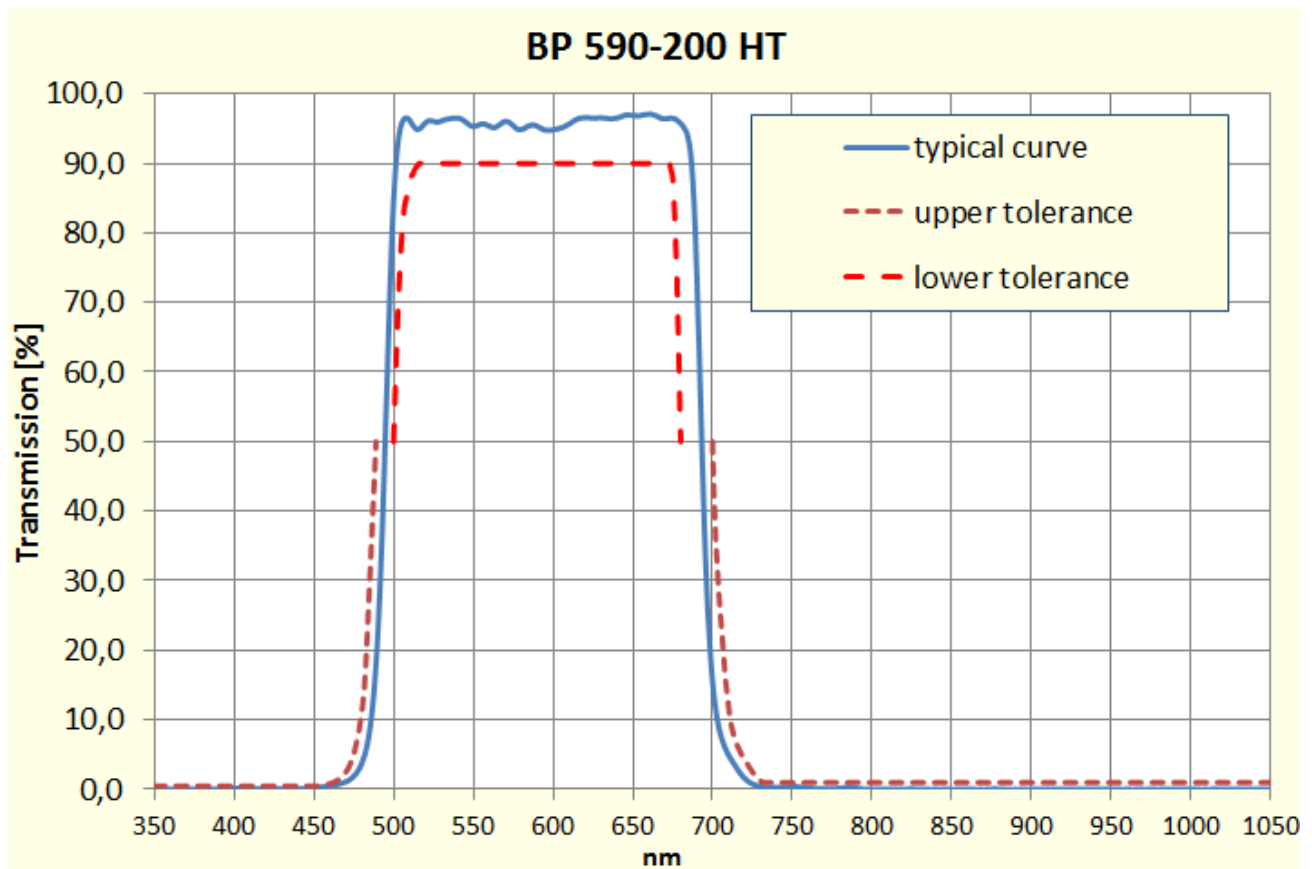

Technical specifications

according to ISO 10110

Angle of incident	0° +/-8°
Wavelength range	595 +/- 5 nm to 690 +/- 7 nm
Transmittance	515 - 670 nm: T > 90%
Blocking	UV - 450 nm: T < 0.5% 735 - 1100 nm: T < 1.0%

unmounted	filter glass	ID	mounted	filter	ID
19 mm	IFG BP 590-200 HT 19,0 2-0001	1082583	CMT	IF BP 590-200 HT CMT	1085679
27 mm	IFG BP 590-200 HT 27,0 2-0001	1082584	SH 25.5	IF BP 590-200 HT SH 25.5	1089733
34 mm	IFG BP 590-200 HT 34,0 2-0001	1082585	SH 27.0	IF BP 590-200 HT SH 27.0	1085815
43 mm	IFG BP 590-200 HT 43,0 2-0001	1082586	SN1 30.5	IF BP 590-200 HT SN1 30.5	1085649
55 mm	IFG BP 590-200 HT 55,0 2-0001	1082587	SH 35.5	IF BP 590-200 HT SH 35.5	
64 mm	IFG BP 590-200 HT 64,0 2-0001	1082588	SH 37.0	IF BP 590-200 HT SH 37.0	1089815
			SH 40.5	IF BP 590-200 HT SH 40.5	1090585
			SH 43.0	IF BP 590-200 HT SH 43.0	
			SH 46.0	IF BP 590-200 HT SH 46.0	
			SH 49.0	IF BP 590-200 HT SH 49.0	
			SH 52.0	IF BP 590-200 HT SH 52.0	
			SH 55.0	IF BP 590-200 HT SH 55.0	1085513
			SH 58.0	IF BP 590-200 HT SH 58.0	
			SH 62.0	IF BP 590-200 HT SH 62.0	
			SH 67.0	IF BP 590-200 HT SH 67.0	

Bandpass Filter BP 635-50 HT

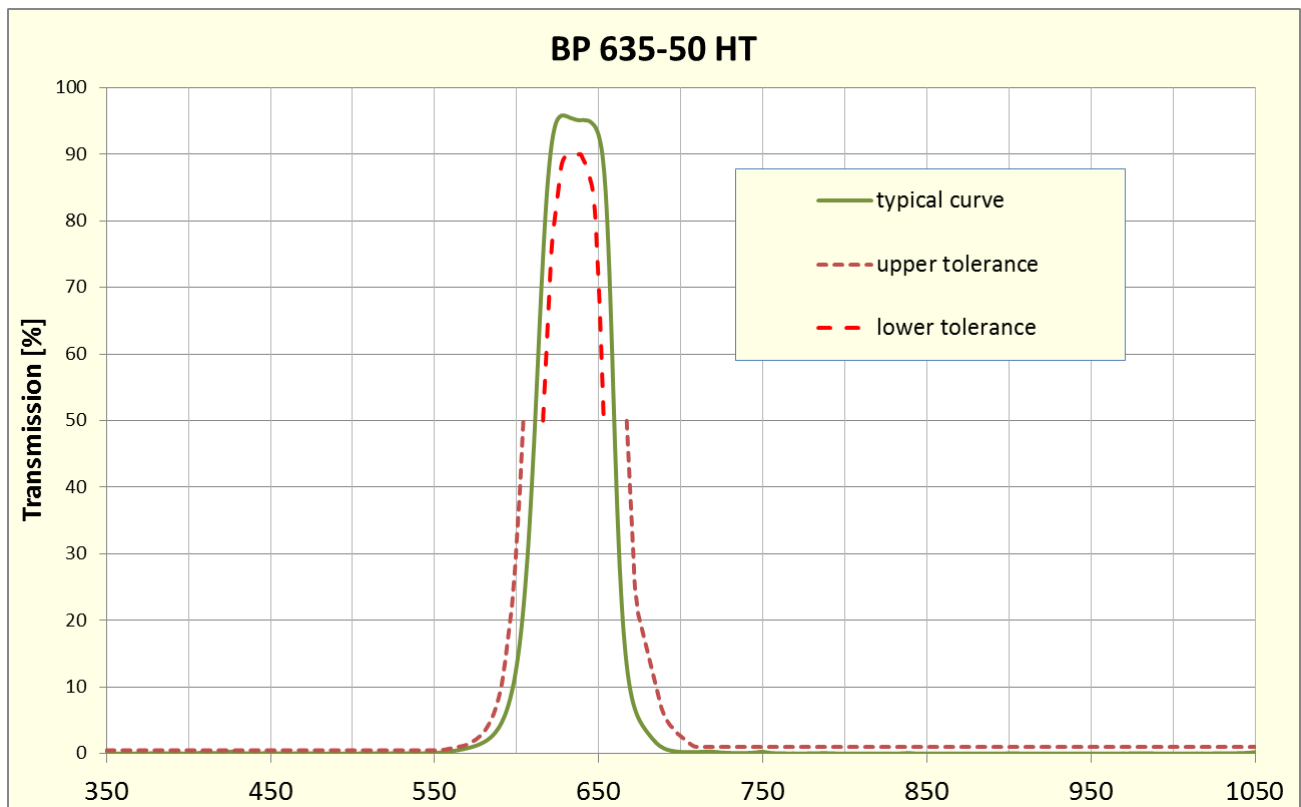

Technical specifications

according to ISO 10110

Angle of incident	0° +/- 8°
Wavelength range	610 +/- 6 nm to 660 +/- 7 nm
Transmittance	630 - 640 nm: T > 90%
Blocking	UV - 550 nm: T < 0.5% 710 - 1050 nm: T < 1.0%

unmounted	filter glass	ID	mounted	filter	ID
19 mm	IFG BP 635-50 HT 19,0 2-0001	1082533	CMT	IF BP 635-50 HT CMT	1085680
27 mm	IFG BP 635-50 HT 27,0 2-0001	1082534	SH 25.5	IF BP 635-50 HT SH 25.5	1084445
34 mm	IFG BP 635-50 HT 34,0 2-0001	1082535	SH 27.0	IF BP 635-50 HT SH 27.0	1084641
43 mm	IFG BP 635-50 HT 43,0 2-0001	1082536	SN1 30.5	IF BP 635-50 HT SN1 30.5	1085091
55 mm	IFG BP 635-50 HT 55,0 2-0001	1082537	SH 35.5	IF BP 635-50 HT SH 35.5	1085185
64 mm	IFG BP 635-50 HT 64,0 2-0001	1082538	SH 37.0	IF BP 635-50 HT SH 37.0	1085816
			SH 40.5	IF BP 635-50 HT SH 40.5	1089923
			SH 43.0	IF BP 635-50 HT SH 43.0	1083606
			SH 46.0	IF BP 635-50 HT SH 46.0	1086649
			SH 49.0	IF BP 635-50 HT SH 49.0	
			SH 52.0	IF BP 635-50 HT SH 52.0	1085814
			SH 55.0	IF BP 635-50 HT SH 55.0	1088488
			SH 58.0	IF BP 635-50 HT SH 58.0	
			SH 62.0	IF BP 635-50 HT SH 62.0	
			SH 67.0	IF BP 635-50 HT SH 67.0	1084985

Bandpass Filter BP 640-100 HT

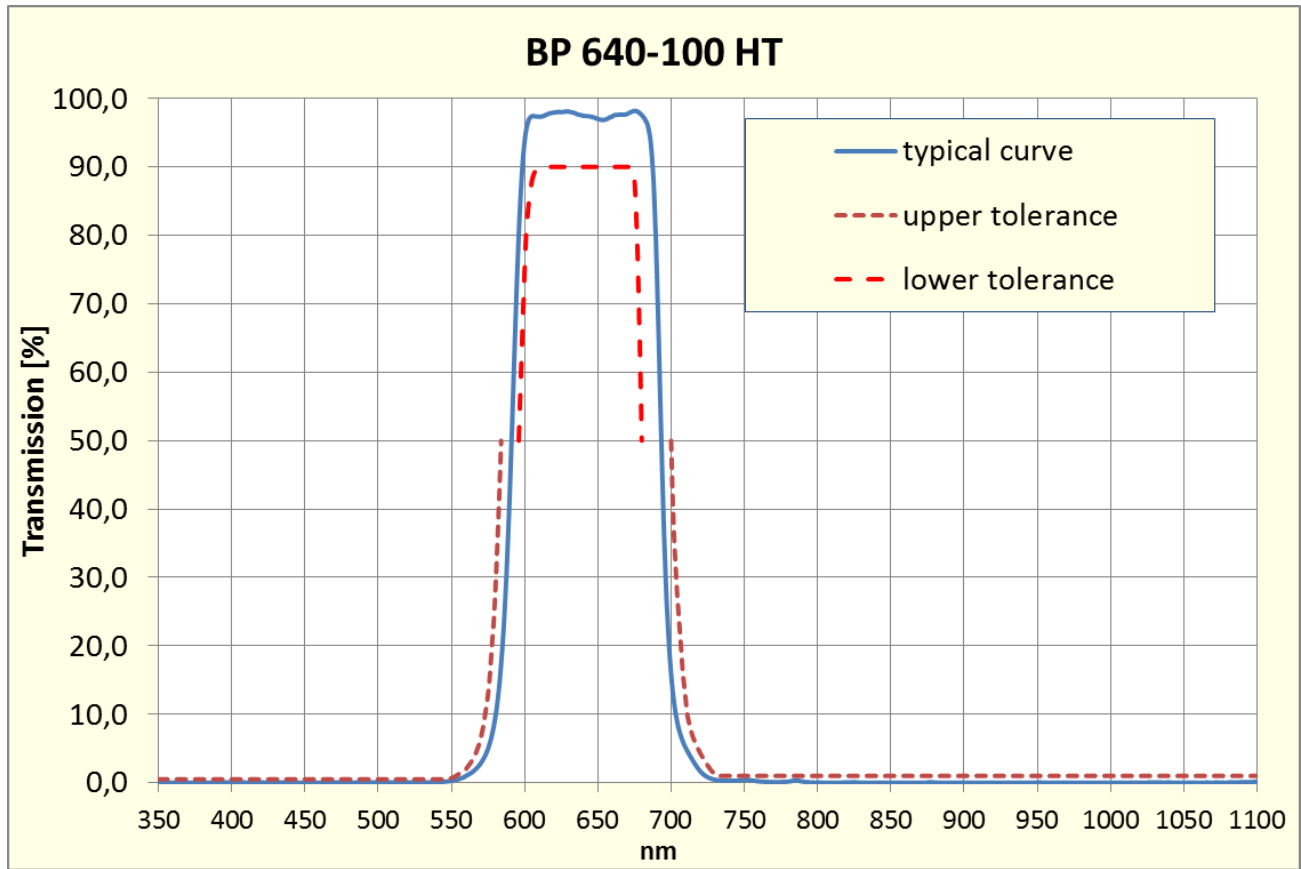

Technical specifications

according to ISO 10110

Angle of incident	0° +/- 8°
Wavelength range	590 +/- 6 nm to 690 +/- 7nm
Transmittance	610 - 670 nm: T > 90%
Blocking	UV - 545 nm: T < 0.5% 735 - 1100 nm: T < 1.0%

unmounted	filter glass	ID	mounted	filter	ID
19 mm	IFG BP 640-100 HT 19,0 2-0001	1082524	CMT	IF BP 640-100 HT CMT	1085681
27 mm	IFG BP 640-100 HT 27,0 2-0001	1082525	SH 25.5	IF BP 640-100 HT SH 25.5	1085707
34 mm	IFG BP 640-100 HT 34,0 2-0001	1082526	SH 27.0	IF BP 640-100 HT SH 27.0	1085328
43 mm	IFG BP 640-100 HT 43,0 2-0001	1082527	SN1 30.5	IF BP 640-100 HT SN1 30.5	1085650
55 mm	IFG BP 640-100 HT 55,0 2-0001	1082528	SH 35.5	IF BP 640-100 HT SH 35.5	1085708
64 mm	IFG BP 640-100 HT 64,0 2-0001	1082529	SH 37.0	IF BP 640-100 HT SH 37.0	1088123
			SH 40.5	IF BP 640-100 HT SH 40.5	1085709
			SH 43.0	IF BP 640-100 HT SH 43.0	1085710
			SH 46.0	IF BP 640-100 HT SH 46.0	1086650
			SH 49.0	IF BP 640-100 HT SH 49.0	
			SH 52.0	IF BP 640-100 HT SH 52.0	1088051
			SH 55.0	IF BP 640-100 HT SH 55.0	
			SH 58.0	IF BP 640-100 HT SH 58.0	1085711
			SH 62.0	IF BP 640-100 HT SH 62.0	
			SH 67.0	IF BP 640-100 HT SH 67.0	1085712

Bandpass Filter BP 660-60 H

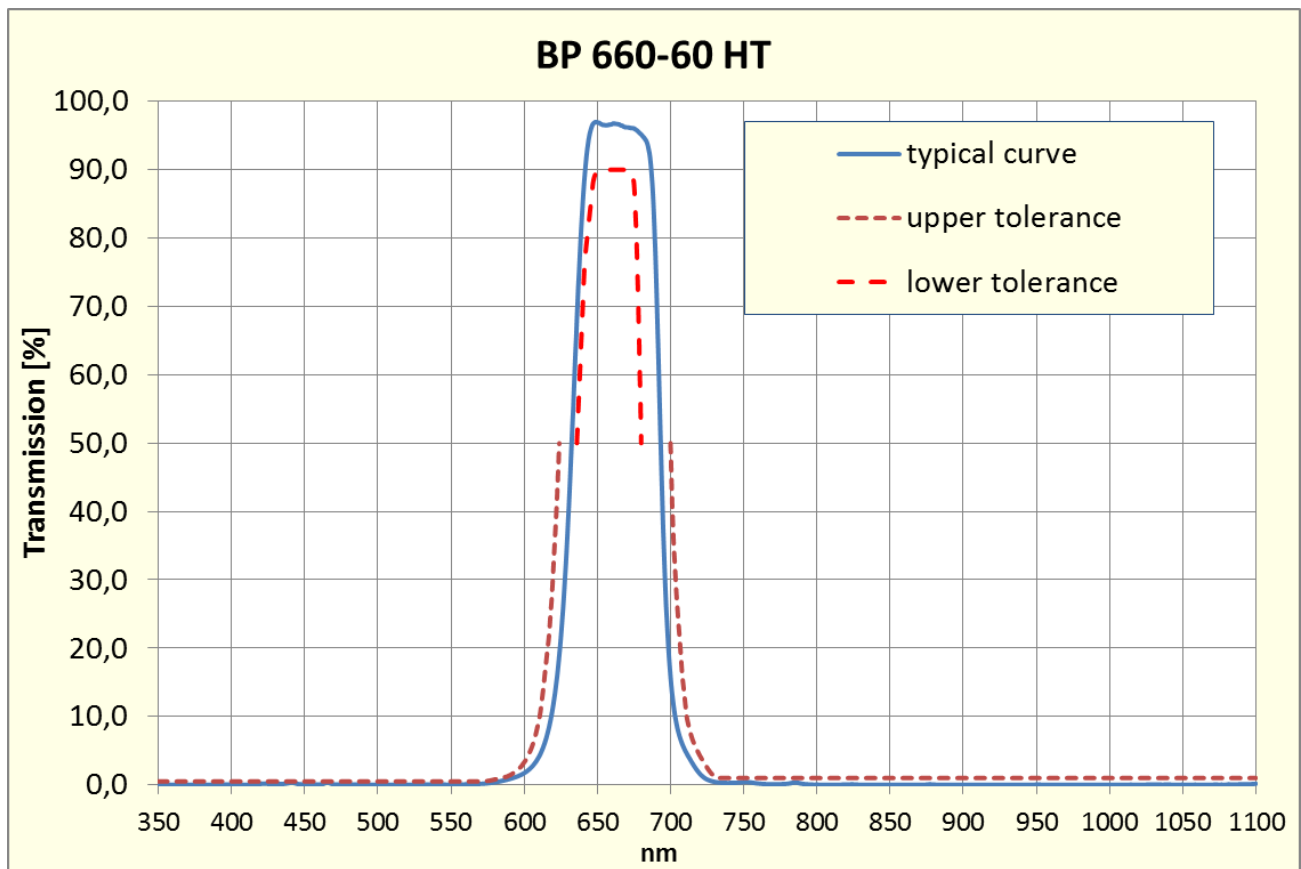

Technical specifications

according to ISO 10110

Angle of incident	0° +/- 8°
Wavelength range	630 +/- 6 nm to 690 +/- 7nm
Transmittance	650 - 670 nm: T > 90%
Blocking	UV - 570 nm: T < 0.5% 735 - 1100 nm: T < 1.0%

unmounted	filter glass	ID	mounted	filter	ID
19 mm	IFG BP 660-60 HT 19,0 2-0001	1082517	CMT	IF BP 660-60 HT CMT	1085682
27 mm	IFG BP 660-60 HT 27,0 2-0001	1082518	SH 25.5	IF BP 660-60 HT SH 25.5	1085714
34 mm	IFG BP 660-60 HT 34,0 2-0001	1082519	SH 27.0	IF BP 660-60 HT SH 27.0	1084557
43 mm	IFG BP 660-60 HT 43,0 2-0001	1082520	SN1 30.5	IF BP 660-60 HT SN1 30.5	1084481
55 mm	IFG BP 660-60 HT 55,0 2-0001	1082521	SH 35.5	IF BP 660-60 HT SH 35.5	1085325
64 mm	IFG BP 660-60 HT 64,0 2-0001	1082522	SH 37.0	IF BP 660-60 HT SH 37.0	1085386
			SH 40.5	IF BP 660-60 HT SH 40.5	1085715
			SH 43.0	IF BP 660-60 HT SH 43.0	1085716
			SH 46.0	IF BP 660-60 HT SH 46.0	1086651
			SH 49.0	IF BP 660-60 HT SH 49.0	1085387
			SH 52.0	IF BP 660-60 HT SH 52.0	1090082
			SH 55.0	IF BP 660-60 HT SH 55.0	1089469
			SH 58.0	IF BP 660-60 HT SH 58.0	1085717
			SH 62.0	IF BP 660-60 HT SH 62.0	
			SH 67.0	IF BP 660-60 HT SH 67.0	1084986

Bandpass Filter BP 680-100 HT

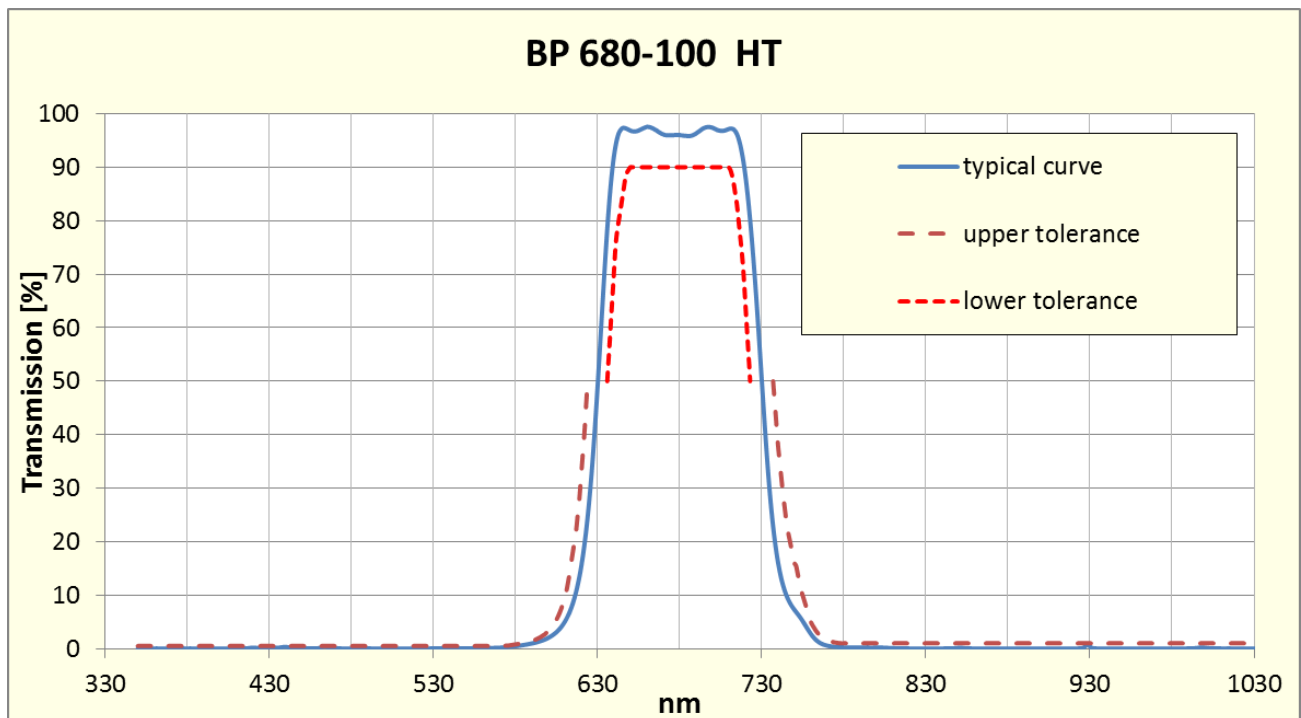

Technical specifications

according to ISO 10110

Angle of incident	0° +/- 8°
Wavelength range	630 +/- 6 nm to 730 +/- 7 nm
Transmittance	650 - 710 nm: T > 90%,
Blocking	UV - 570 nm: Tabs < 0.5% 780 - 1100 nm: T < 1.0%

unmounted	filter glass	ID	ID	mounted	filter	ID
		[2 mm thickness]	[1 mm thickness]			
19 mm	IFG BP 680-100 HT 19,0 2-0001	1082880		CMT	IF BP 680-100 HT CMT	1085683
27 mm	IFG BP 680-100 HT 27,0 2-0001	1082881		SH 25.5	IF BP 680-100 HT SH 25.5	1089734
34 mm	IFG BP 680-100 HT 34,0 2-0001	1082882	1095260	SH 27.0	IF BP 680-100 HT SH 27.0	1085697
43 mm	IFG BP 680-100 HT 43,0 2-0001	1082883		SN1 30.5	IF BP 680-100 HT SN1 30.5	1085651
55 mm	IFG BP 680-100 HT 55,0 2-0001	1082884		SH 35.5	IF BP 680-100 HT SH 35.5	1088047
64 mm	IFG BP 680-100 HT 64,0 2-0001	1082885		SH 37.0	IF BP 680-100 HT SH 37.0	
				SH 40.5	IF BP 680-100 HT SH 40.5	
				SH 43.0	IF BP 680-100 HT SH 43.0	1085532
				SH 46.0	IF BP 680-100 HT SH 46.0	1086652
				SH 49.0	IF BP 680-100 HT SH 49.0	
				SH 52.0	IF BP 680-100 HT SH 52.0	1091534
				SH 55.0	IF BP 680-100 HT SH 55.0	
				SH 58.0	IF BP 680-100 HT SH 58.0	
				SH 62.0	IF BP 680-100 HT SH 62.0	
				SH 67.0	IF BP 680-100 HT SH 67.0	

Bandpass Filter BP 865-100 HT

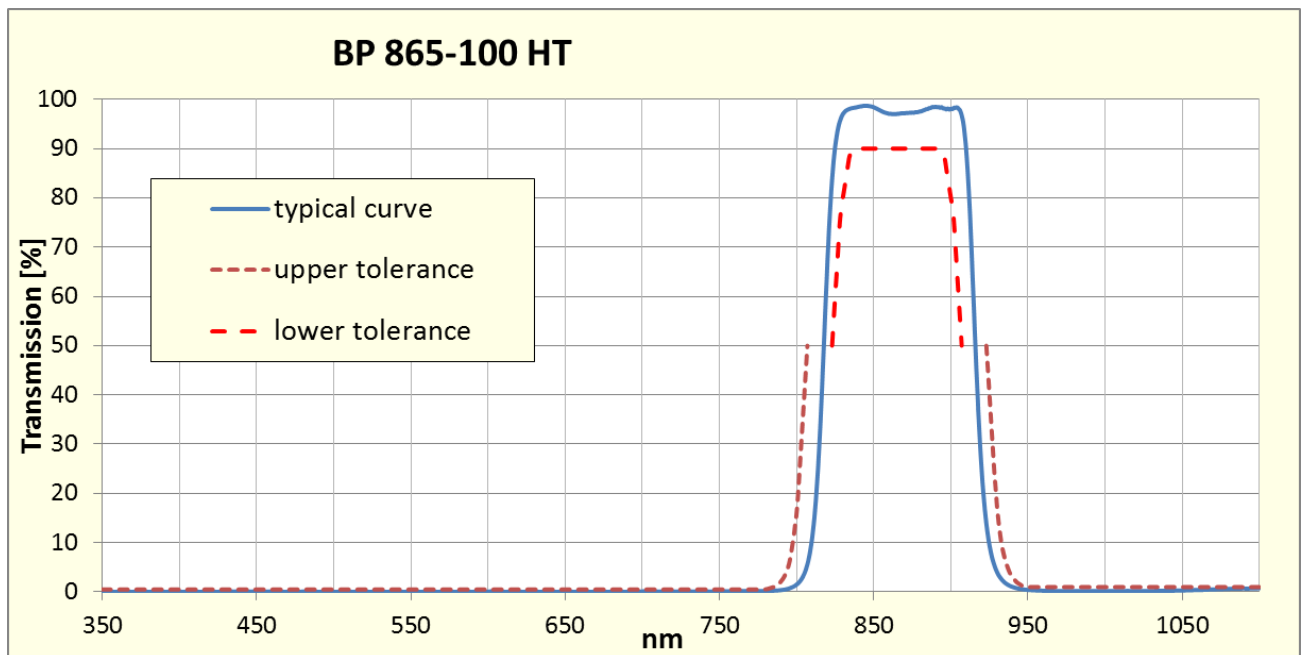

Technical specifications

according to ISO 10110

Angle of incident	0° +/- 8°
Wavelength range	815 +/- 8 nm to 915 +/- 9 nm
Transmittance	840 - 890 nm: T > 90%
Blocking	UV - 780 nm: T < 0.5% 950 - 1100 nm: T < 1.0%

unmounted	filter glass	ID	mounted	filter	ID
19 mm	IFG BP 865-100 HT 19,0 2-0001	1082468	CMT	IF BP 865-100 HT CMT	1085684
27 mm	IFG BP 865-100 HT 27,0 2-0001	1082469	SH 25.5	IF BP 865-100 HT SH 25.5	1085691
34 mm	IFG BP 865-100 HT 34,0 2-0001	1082470	SH 27.0	IF BP 865-100 HT SH 27.0	1085692
43 mm	IFG BP 865-100 HT 43,0 2-0001	1082471	SN1 30.5	IF BP 865-100 HT SN1 30.5	1084556
55 mm	IFG BP 865-100 HT 55,0 2-0001	1082472	SH 35.5	IF BP 865-100 HT SH 35.5	1088308
64 mm	IFG BP 865-100 HT 64,0 2-0001	1082473	SH 37.0	IF BP 865-100 HT SH 37.0	1088391
			SH 40.5	IF BP 865-100 HT SH 40.5	1085693
			SH 43.0	IF BP 865-100 HT SH 43.0	1085695
			SH 46.0	IF BP 865-100 HT SH 46.0	1086653
			SH 49.0	IF BP 865-100 HT SH 49.0	1088448
			SH 52.0	IF BP 865-100 HT SH 52.0	1090388
			SH 55.0	IF BP 865-100 HT SH 55.0	
			SH 58.0	IF BP 865-100 HT SH 58.0	1085696
			SH 62.0	IF BP 865-100 HT SH 62.0	1088073
			SH 67.0	IF BP 865-100 HT SH 67.0	1084987

Bandpass Filter

Next to the standard sizes we offer more on request. Schneider-Kreuznach provides professional highly accurate μ water jet cutting capability. This technology allows cutting almost any needed shape. More mounted diameters are available for high volume on request.

An easy method to create a customized bandpass is to combine a shortpass filter with a longpass filter. This is an effective way when the standard range of bandpass filters does not fit the application. Schneider-Kreuznach offers a series of shortpass filters and longpass filters.

See also Schneider-Kreuznach UV-IR cut filter as alternative for broadband bandpass filters.

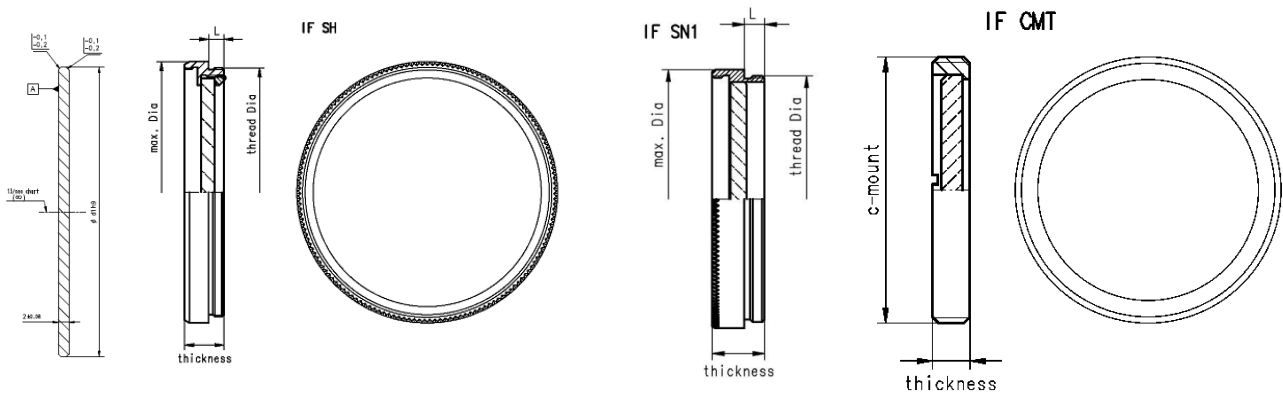

Contact

Headquartes Europe

Jos. Schneider Optische Werke GmbH
Ringstraße 132
55543 Bad Kreuznach
Germany

+49 671 601-205
cs@schneiderkreuznach.com
www.schneiderkreuznach.com

Offices America

+1 800 645 7239 (East Coast)
+1 800 228 1254 (West Coast)
info@schneideroptics.com
www.schneiderkreuznach.com

Office Asia

+86 755 8832 1170
info@schneider-asiapacific.com
www.schneiderkreuznach.com

Office Singapore

+65 9488 0062
thongv@schneiderkreuznach.com
www.schneiderkreuznach.com