

L300 Linear Light

CONNECT-A-LIGHT

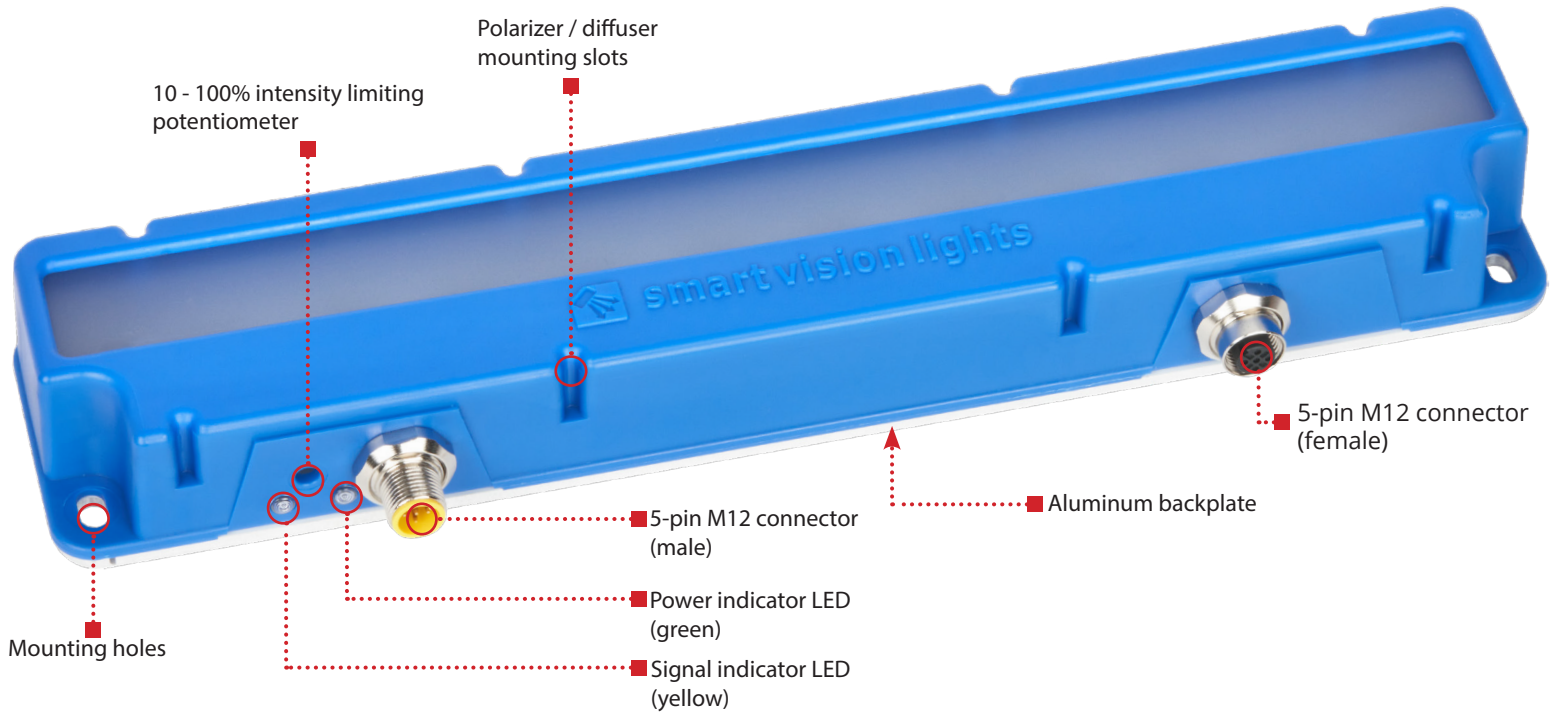

The L300 is a linear light featuring an integrated constant current driver with a lux value of up to 54,000. NPN or PNP triggers can be used to control the light for either strobed or continuous operation. Light intensity can be controlled via 1 - 10 VDC analog intensity line or set manually by the intensity limiting potentiometer. The L300 can be daisy-chained with up to six lights in series using a standard 5-pin M12 jumper cable.

L300 HIGHLIGHTS

Warranty 10 YEAR	Tested IEC 62471	Compliant CE ROHS	Rated IP 50	Connector 5-PIN M12
--------------------------------	--------------------------------	---------------------------------	---------------------------	-----------------------------------

- ✓ Daisy-chain up to six L300 linear lights using a standard 5-pin M12 jumper cable
- ✓ High-impact injection molded housing
- ✓ Built-in potentiometer for physical intensity limiting
- ✓ Built-in status indicators
- ✓ Lowest profile full-sized linear light

SPECIFICATIONS

Electrical Input	24 VDC +/- 5%
Input Current	Max. 700 mA
Input Power	Max. 17 W
PNP Trigger	2.8 mA @ 4VDC 8.8 mA @ 12VDC 17.6 mA @ 24VDC
NPN Trigger	14.4 mA @ Common (0VDC)
Trigger Input	PNP > +4 VDC (24 VDC max.) to activate or NPN ≥ GND <1VDC to activate (not both)
Strobe Duration	Min. 30 μs Max. ∞
Strobe Trigger Latency	10 μs
Power Indicator	Turns green when powered up
Status Indicators	Strobe indicator will turn yellow when on
Intensity Limit	270° turn-pot. Turn clockwise to increase intensity limit.
Analog Intensity	The output is adjustable from 10% - 100% of intensity limit by a 1 - 10 VDC signal. Jumpering pin 5 to pin 1 will provide maximum intensity
Connection	5-pin M12 connector
Operating Temperature	-10° to 40° C (14° to 104° F) RH max 80% non-condensing humidity
Storage Temperature	-20° to 70° C (-4° to 158° F) RH max 80% non-condensing humidity
IP Rating	IP50
Weight	~0.81 lbs ~370 g
Compliances	CE, IEC 62471, RoHS
Warranty	10 years ¹

¹See SmartVisionLights.com/warranty for details

WIRING CONFIGURATION

CONTINUOUS OPERATION MODE

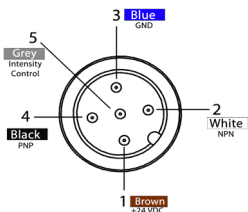

Pin layout for light (Male Connector)

Pins	Function	Signal	Wire Color
1	Power In	+24VDC	BROWN
2	NPN	Sinking Signal	WHITE
3	GND	Ground	BLUE
4	PNP	Sourcing Signal	BLACK
5	Intensity Control	1-10VDC	GREY*

For maximum intensity, tie pin 5 to pin 1 at +24VDC.

For continuous mode: PNP (pin 4) can be tied to +24 VDC (pin 1) **or** NPN (pin 2) can be tied to Ground (pin 3).

For proper light function, apply either a PNP or NPN signal, not both.

Failure to supply light with correct input current will result in inconsistent lighting behavior.

(see Product Specifications for requirements)

LIGHTING PATTERNS

The L300 is recommended to be used at a working distance between 300 mm to 2000 mm. Illuminance values taken on white light - 5700K

Standard (16°) lighting patterns

Illuminance -vs- Working Distance

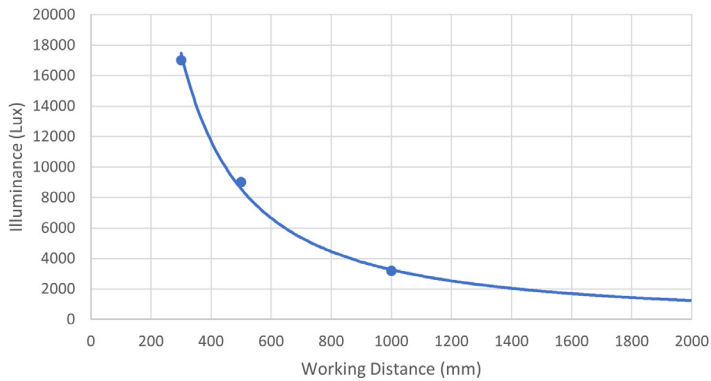

Beam Size at 80% Max Intensity -vs- Working Distance

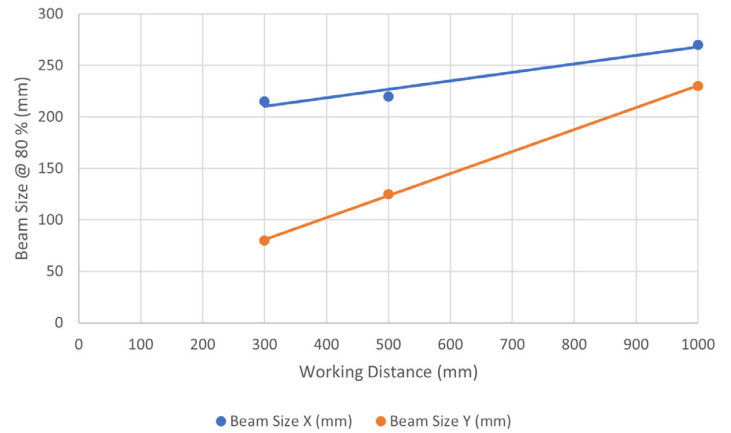

Wide (30°) lighting patterns

Illuminance -vs- Working Distance

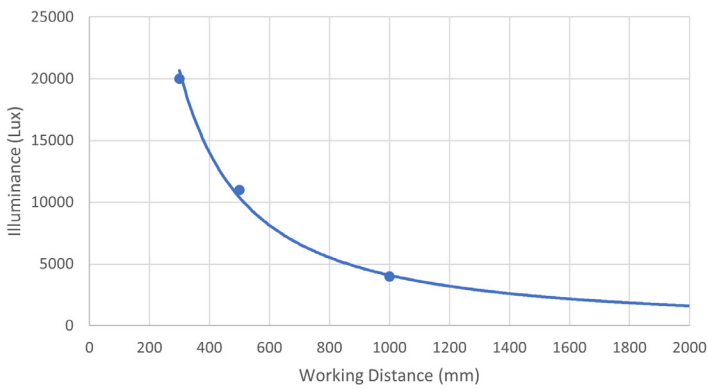

Beam Size at 80% Max Intensity -vs- Working Distance

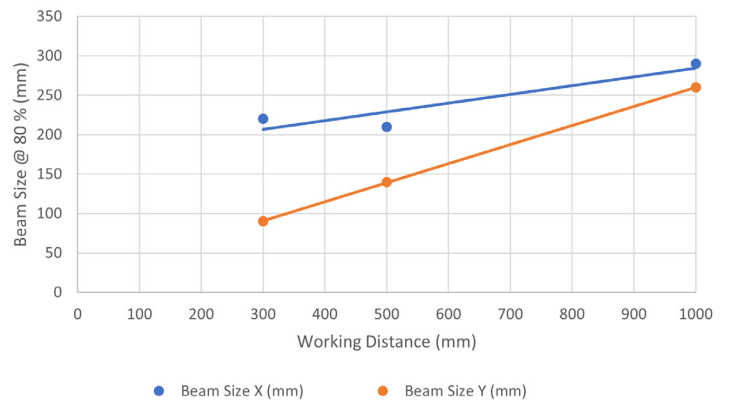

Line (10° x 50°) lighting patterns

Illuminance -vs- Working Distance

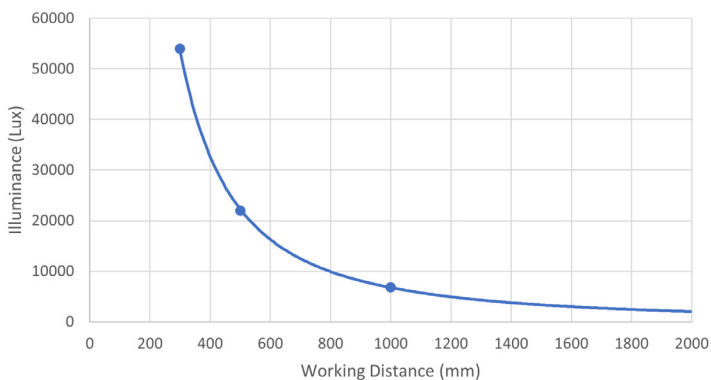

Beam Size at 80% Max Intensity -vs- Working Distance

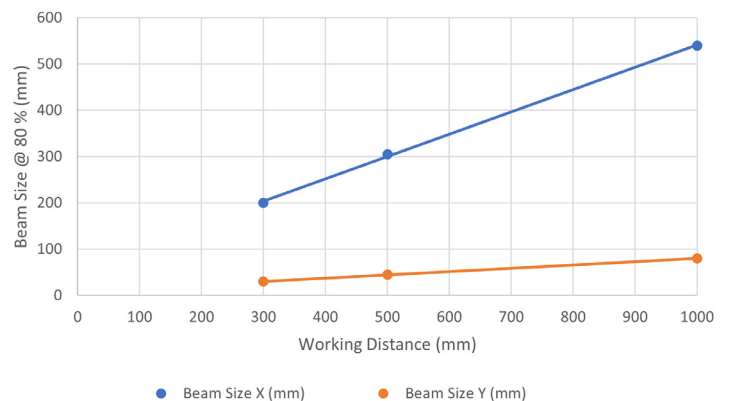

BEAM PATTERNS

The L300 is recommended to be used at a working distance between 300 mm to 2000 mm. Illuminance values taken on white light - 5700K

Standard (16°) beam patterns

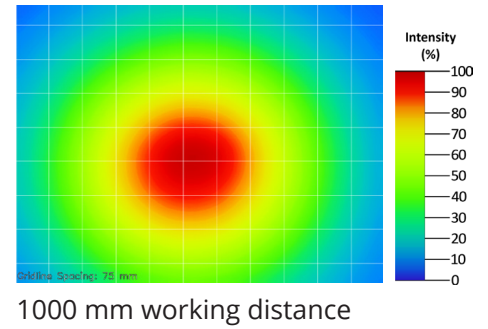
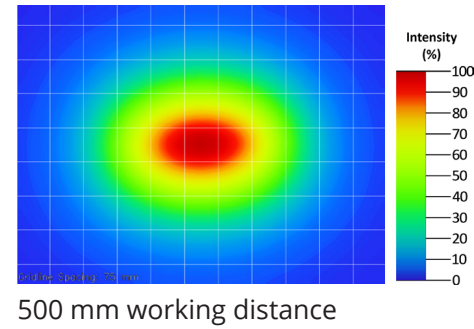
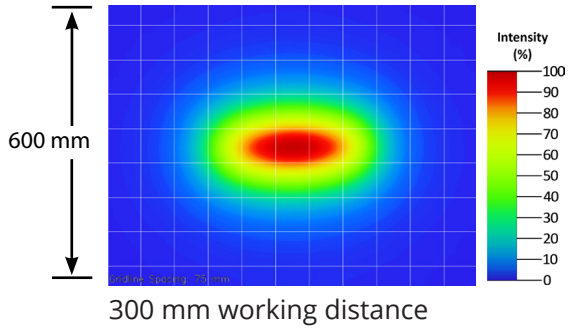

Wide (30°) beam patterns

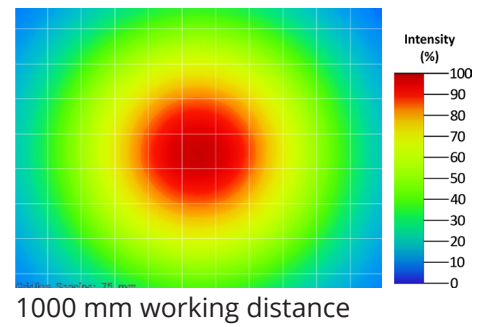
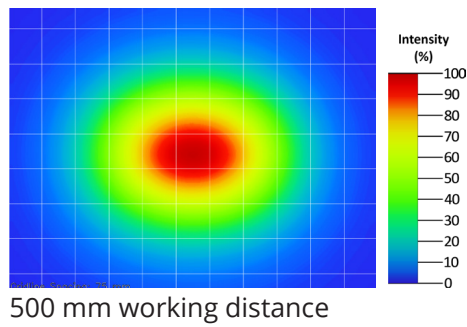
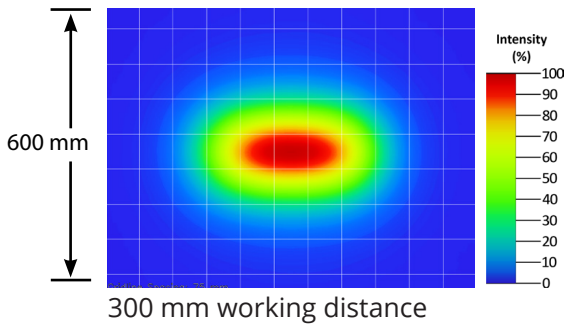

Line (10° x 50°) beam patterns

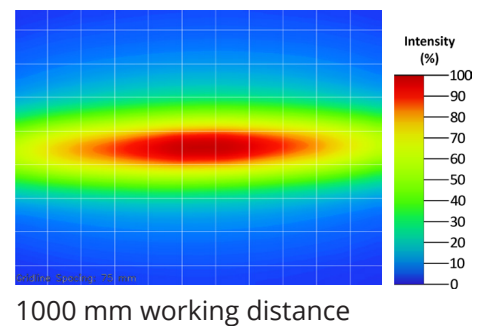
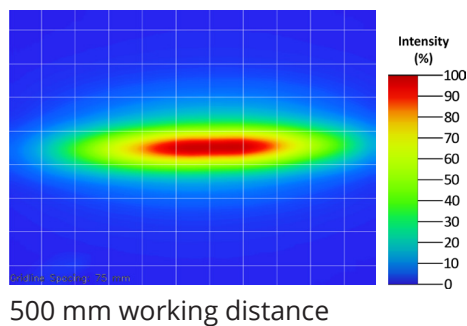
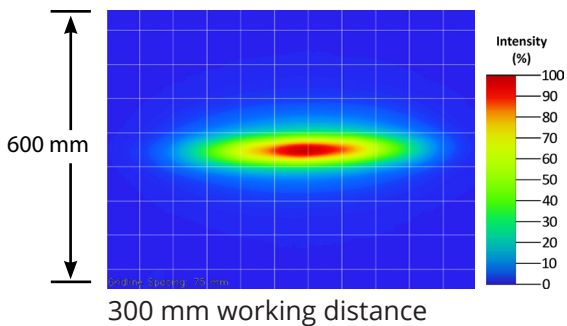

LENS OPTICS

NARROW (Standard)

Narrow, 16° angle-cone lenses are standard. Standard lenses create a narrow beam of illumination and are used for long working distances.



LINE

Line, with a 10° width and a 50° fan angle, projects a thin, narrow beam of illumination.

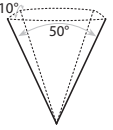

WIDE

Wide, 30° angle-cone lenses create a large area of illumination. They create a floodlight effect and can be used for short working distances.



MOUNTING

Two M5 holes are located on the bottom of the light for easy mounting.

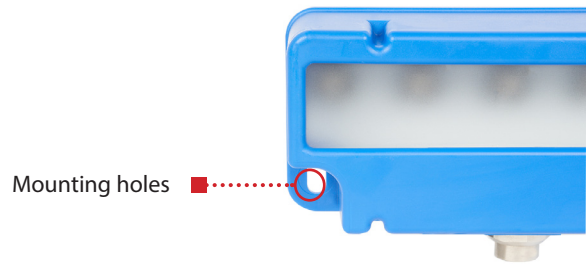

DAISY-CHAIN LIGHTS

L300 Series of lights requires the use of a standard 5-pin M12 jumper cable to effectively parallel up to six L300 lights.

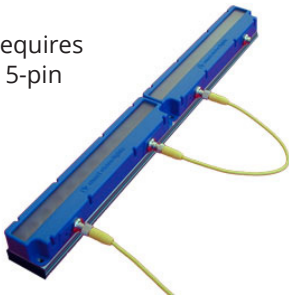

There is consistent spacing between LEDs as lights are connected together.

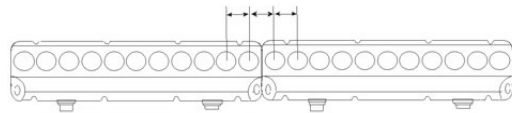

EYE SAFETY

According to IEC 62471:2006. Full documentation available upon request with purchase of product.

Notice

Exempt Group: No photobiological hazard to eyes or skin even for continuous, unrestricted use. Applicable for wavelengths 625, 850, and 940.

Caution

Risk Group 1: Possibly hazardous optical radiation emitted from this product. Do not stare at operating lamp. May be harmful to eyes. Safe for most applications except prolonged exposure. Applicable for wavelengths 470, 505, 530, and WHI.

Warning

Risk Group 2: UV emitted from this product. Eye or skin irritation may result from exposure. Use appropriate shielding. Does not pose optical hazard if aversion responses limit exposure. Applicable for wavelength 365 and 395.

ILLUMINATION

The L300 works best for:

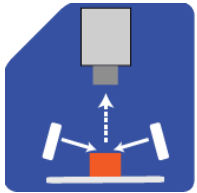

Dark Field

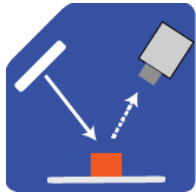

Bright Field

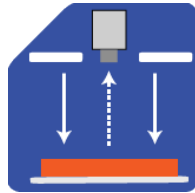

Direct Lighting

PART NUMBER GUIDE

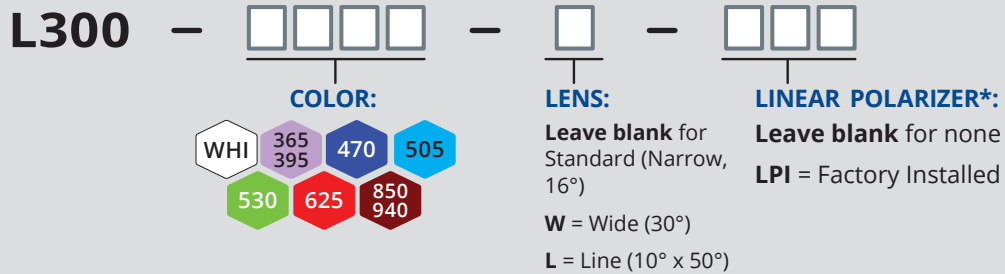

Part Number Examples:

- L300-625** L300, 625 nm Red Wavelength, Standard (Narrow) Lens
- L300-WHI-L** L300, White, Line Lens
- L300-470-W-LPI** L300, 470 nm Blue Wavelength, Wide Lens, with Linear Polarizer Installed

Line lens optic not available for UV wavelengths.

Additional wavelengths and lens options available upon request.

**For lights with lenses, running in continuous operation while using a linear polarizer with certain wavelengths (e.g., white, blue) may burn the polarizer. Incorrect usage of the polarizer is not covered by warranty.*

ACCESSORIES

Power Cables



Length	Part Number
5 m	5PM12-5
10 m	5PM12-10
15 m	5PM12-15

Jumper Cables (Daisy Chain)



Length	Part Number
300 mm	5PM12-J300
1000 mm	5PM12-J1000
2000 mm	5PM12-J2000

Mount



Description	Part Number
3-Axis Pan and Tilt Mount	PB300-M5

Mounting Rails



Length	Part Number
300 mm	LEXT300
600 mm	LEXT600
900 mm	LEXT900
1200 mm	LEXT1200
Custom sizes available	

Diffuser

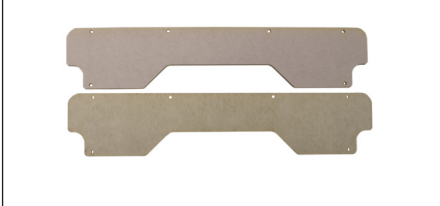

Description	Part Number
Diffuser Kit	L300-DKIT

Linear Polarizer



Description	Part Number
Linear Polarizer Kit	L300-LP

PRODUCT DRAWINGS

*CAD files available on our website
Drawings are in mm

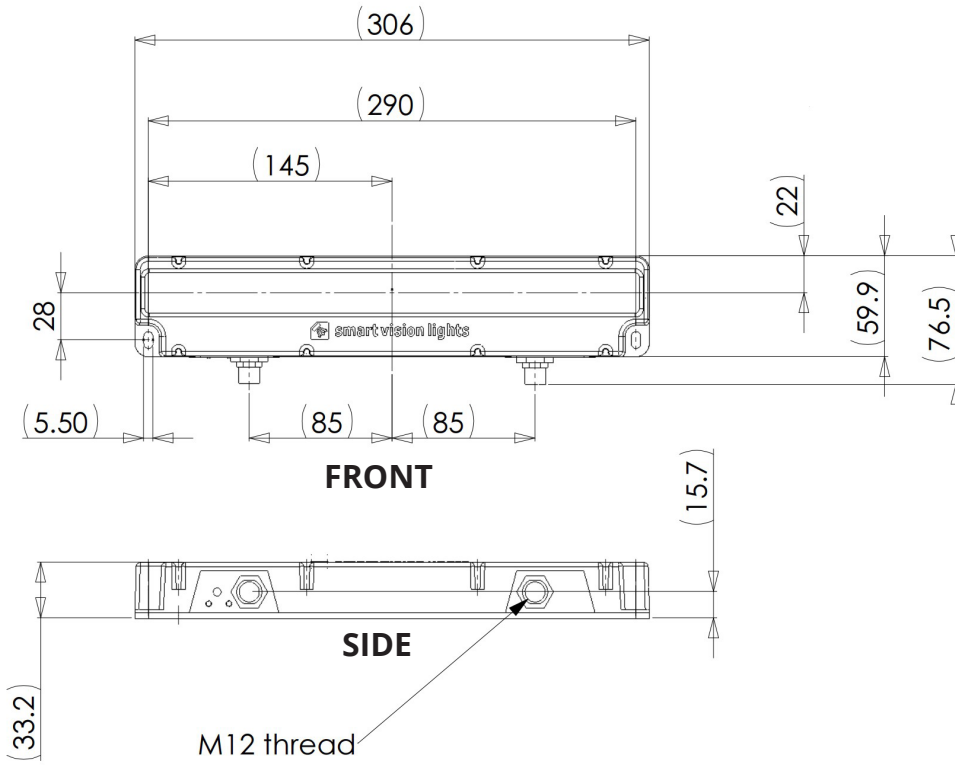

GLOSSARY

This glossary covers all Smart Vision Lights product families; some content in this section may not apply to this specific light.

TERMINOLOGY

Continuous Operation The light stays on continuously.

OverDrive™ Integrated driver that produces a high-current strobe to the LEDs to drive them beyond their nominal continuous operation output.

Multi-Drive™ Integrated driver that combines continuous operation and OverDrive™ strobe mode

NanoDrive™ Integrated driver that provides fast switching where the light can go from off to on in less than 500 ns.

Built-in Driver The driver contained within the light that controls the current to the LEDs and provides PNP, NPN, and analog dimming controls.

SmartVisionLink™ Integrated feature that enables lighting control through the Bluetooth module and app.

Camera to Light Connect the light directly to the camera, without the need for additional controllers or equipment.

Polarizers Filters that reduce reflections on specular surfaces.

Diffusers Widens the angle of emission by scattering light in all directions.

Pattern Area Lighting Modulated lighting pattern placed over a backlight's surface used to enhance defect detection on transparent and glossy surfaces

SafeStrobe Limiter to keep the light in safe working parameters.

Direct Connect Connect lights in a series without the use of cables.

Daisy Chain Connect lights in a series with the use of cables.

TYPES OF ILLUMINATION

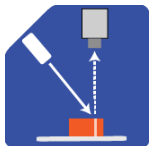

Projector

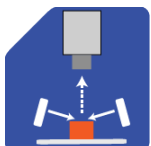

Dark Field

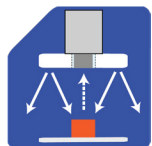

Radial



Bright Field

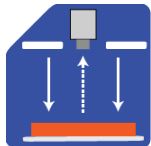

Direct

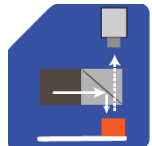

Axial

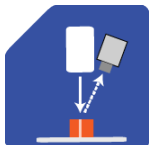

Line

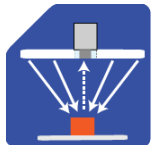

Diffuse Panel

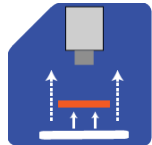

Backlight

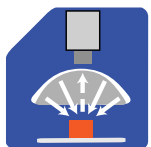

Dome
"Light Tent"

COMMON COLOR / WAVELENGTHS LEGEND

Wavelengths options range from 365 nm to 1650 nm.*
Additional wavelengths available for many light families.

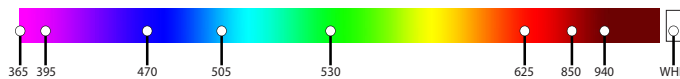

*See Part Number section for **this light's** available standard wavelengths.



Shortwave Infrared LEDs are available in 1050 nm, 1200 nm, 1300 nm, 1450 nm, 1550 nm, and 1650 nm.*

*Check Part Number section to see if **this light** is available in SWIR wavelengths.



ISO 9001:2015 Certified QMS