

# LCZE300

## Linear Light DIRECT CONNECT

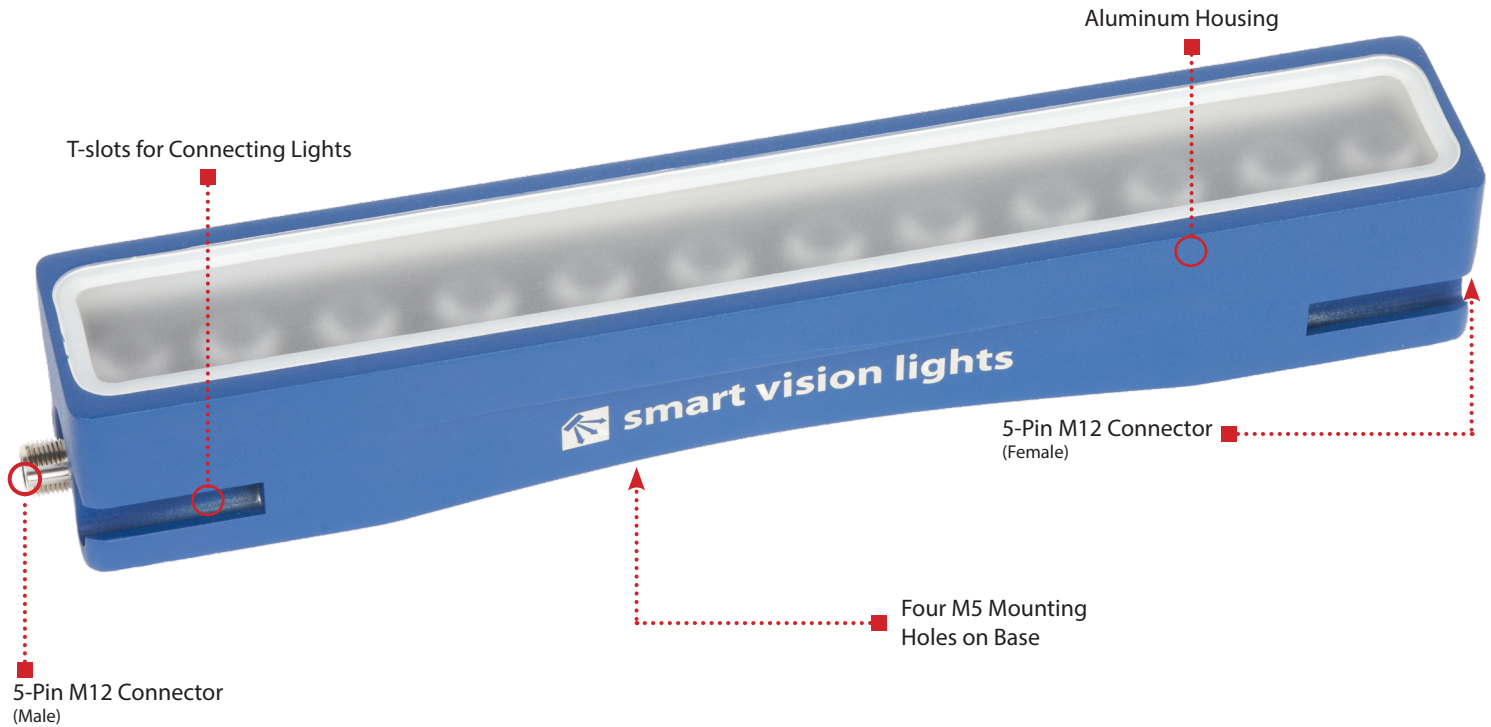

The LCZE300 is a SmartVisionLink™-enabled linear light. With the addition of the BTM-1000 Bluetooth module, the LCZE300 can be wirelessly adjusted for intensity levels. The LCZE300 can be connected in a series of up to six lights, either through direct-connect or daisy-chain, to create a total of 6 independently controllable lighting zones.

### LCZE300 HIGHLIGHTS

Warranty <b>10 YEAR</b>	Tested <b>IEC 62471</b>	Compliant <b>CE ROHS</b>	Rated <b>IP 65</b>	Connector <b>5-PIN M12</b>
--------------------------------	--------------------------------	---------------------------------	---------------------------	-----------------------------------

- ✓ Connect up to six LCZE300 linear lights
- ✓ SmartVisionLink™-enabled provides easy intensity adjustment in both continuous and OverDrive™ modes
- ✓ Multi-Drive™ provides both OverDrive™ and continuous mode functionality
- ✓ Industrial aluminum housing

## SPECIFICATIONS

	Continuous Operation	OverDrive™ Operation
Electrical Input	24 VDC +/- 5%	
Input Current	Max. 750 mA	Peak 4.5 A during strobe
Input Power	Max. 18 W	Peak 108 W during strobe
PNP Trigger	2 mA @ 4VDC   7 mA @ 12VDC   13.4 mA @ 24VDC	
NPN Trigger	12 mA @ Common (0VDC)	
Mode Control	Connect pin 5 to 1 - 10 VDC (10 - 100% output); 24VDC (Max)	Connect pin 5 to GND (See wiring configuration for more information)
Trigger Input	PNP > +3.3 VDC (24 VDC max.) to activate <b>or</b> NPN ≥ GND <1VDC to activate ( <b>not both</b> )	
Strobe Duration	Min. 30 μs   Max. ∞	Min. 30 μs   Max. 50 ms
Strobe Trigger Delay		
Strobe Frequency	Max 4 kHz or 1 / Duty Cycle as calculated, whichever is less. <sup>1</sup>	
Analog Intensity	The output is adjustable from 10% - 100% by a 1 - 10 VDC signal. Jumping pin 5 to pin 1 will provide maximum intensity. Intensity can be remotely adjusted via SmartVisionLink™ <sup>2</sup>	Light is set to maximum intensity by default in OverDrive™ mode and can only be adjusted via SmartVisionLink™ <sup>2</sup>
Connection	5-pin M12 connector	
Operating Temperature	-10° to 40° C (14° to 104° F)   RH max 80% non-condensing humidity	
Storage Temperature	-20° to 70° C (-4° to 158° F)   RH max 80% non-condensing humidity	
IP Rating	IP65	
Weight	~0.9 kg   ~2.0 lb	
Compliances	CE, IEC 62471, RoHS	
Warranty	10 years <sup>3</sup>	

<sup>1</sup>See page 8 for more information

<sup>2</sup>SmartVisionLink™ requires the purchase of the BTM-1000 bluetooth module, sold separately, and the SmartVisionLink™ app, free to download on the Apple App and Google Play stores.

<sup>3</sup>See [SmartVisionLights.com/warranty](http://SmartVisionLights.com/warranty) for details.

## WIRING CONFIGURATION

### CONTINUOUS OPERATION MODE

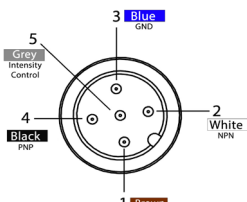

Pin layout for light (Male Connector)

Pins	Function	Signal	Wire Color
1	Power In	+24VDC	BROWN
2	NPN	Sinking Signal	WHITE
3	GND	Ground	BLUE
4	PNP	Sourcing Signal	BLACK
5	Intensity Control	1-10VDC	GREY

For maximum intensity, tie pin 5 to pin 1 at +24 VDC.

For continuous mode: PNP (pin 4) can be tied to +24 VDC (pin 1) **or** NPN (pin 2) can be tied to Ground (pin 3).

For proper light function, apply either a PNP or NPN signal, not both.

Failure to supply light with correct input current will result in inconsistent lighting behavior.

(see Product Specifications for requirements)

## WIRING CONFIGURATION (continued)

### OVERDRIVE™ OPERATION MODE

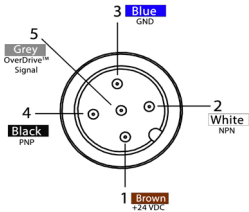

Pin layout for light (Male Connector)

Pins	Function	Signal	Wire Color
1	Power In	+24VDC	BROWN
2	NPN	Sinking Signal	WHITE
3	GND	Ground	BLUE
4	PNP	Sourcing Signal	BLACK
5	OverDrive™ Signal	Ground	GREY

To enable OverDrive™ mode, tie pin 5 to pin 3.

For proper light function, apply either a PNP or NPN signal, not both.

Failure to supply light with correct input current will result in inconsistent lighting behavior.  
(see Product Specifications for requirements)

## CONNECTING A 5-PIN M12 CABLE

**WARNING:**  
When connecting a 5-pin M12 cable to the male connector on the LCZE300, do not twist the cable.  
Tighten the nut only. Twisting the cable will result in damage to the pins.

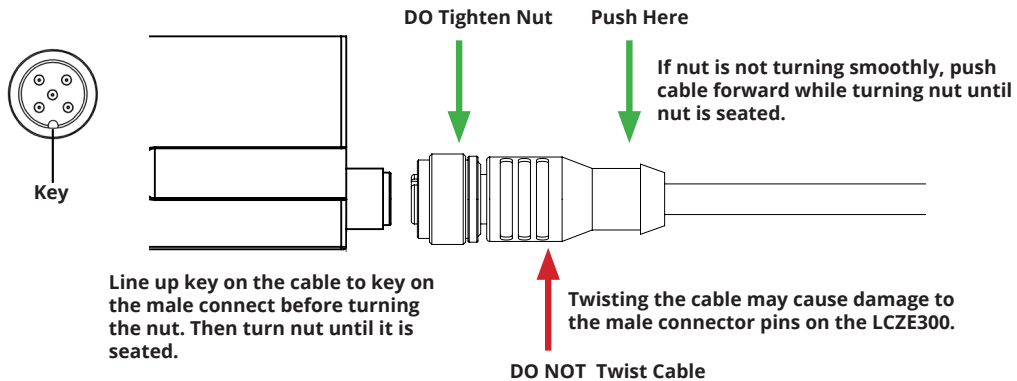

**WARNING:**  
Smart Vision Lights does not recommends using a right angle cable with the LCZE300.

If a right angle cable is required, do not rotate the connector or cable.

Damage caused by a right angle cable will result in the warranty being voided.

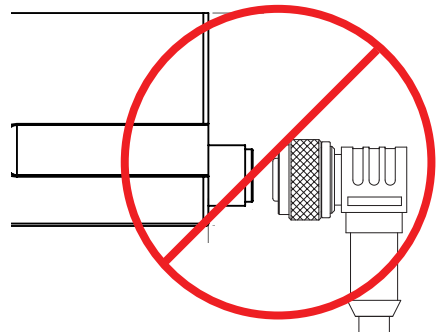

# LIGHTING PATTERNS

The LCZE300 is recommended to be used at a working distance between 300 mm to 2000 mm. Illuminance values taken on white light - 5700K

## Standard (10°) lighting patterns

Illuminance -vs- Working Distance

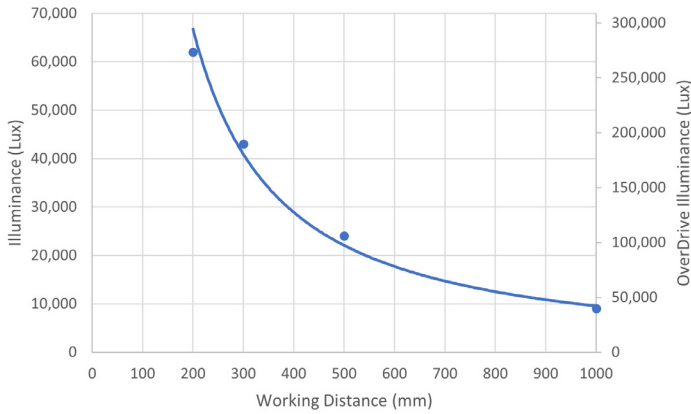

Beam Size at 80% Max Intensity -vs- Working Distance

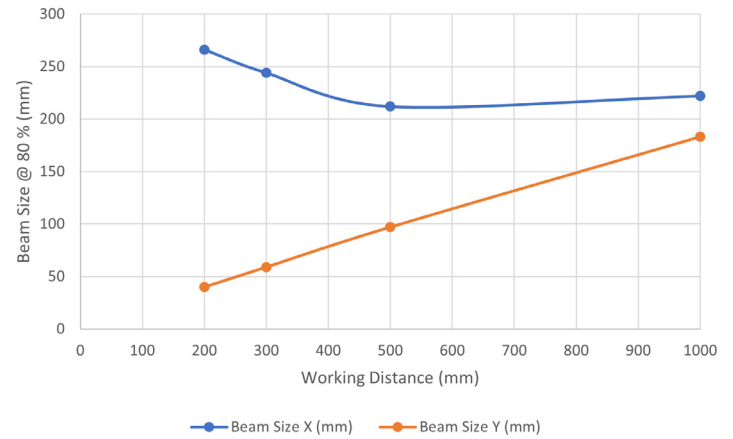

## Wide (25°) lighting patterns

Illuminance -vs- Working Distance

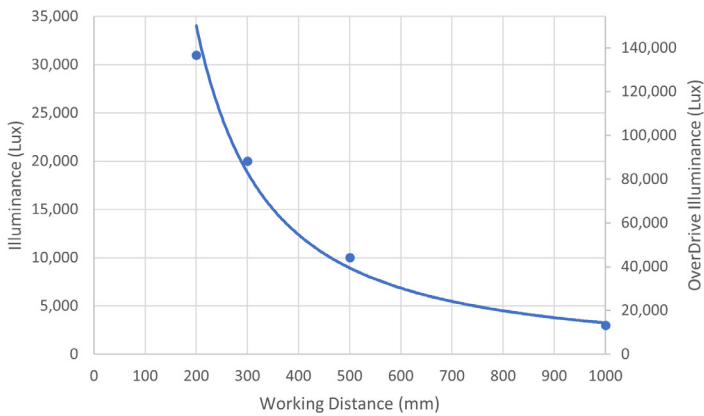

Beam Size at 80% Max Intensity -vs- Working Distance

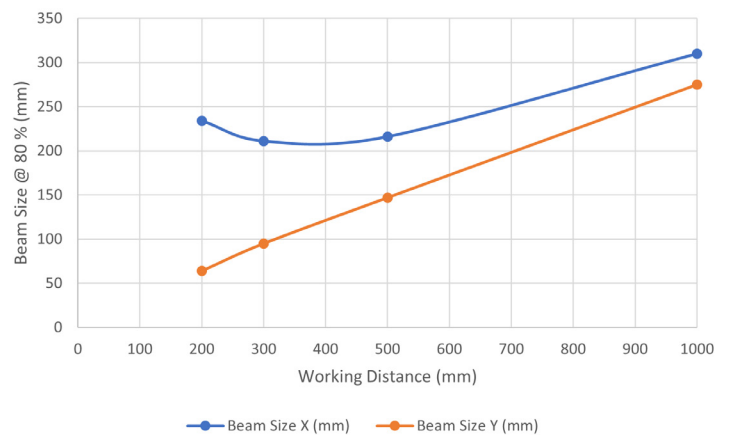

## LIGHTING PATTERNS (continued)

### Line (10° x 50°) lighting patterns

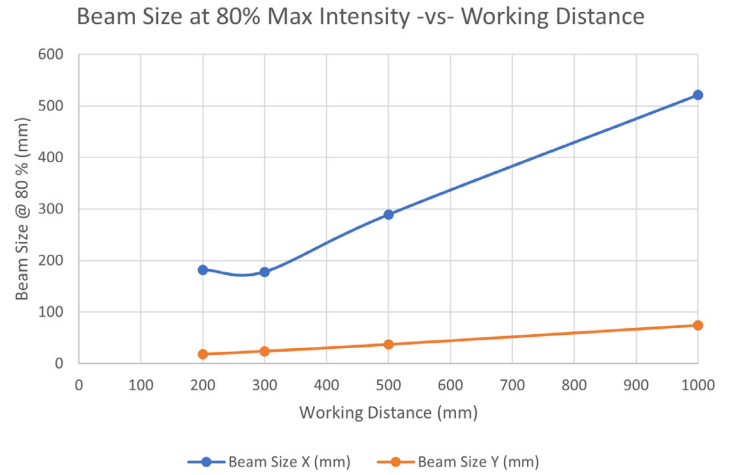
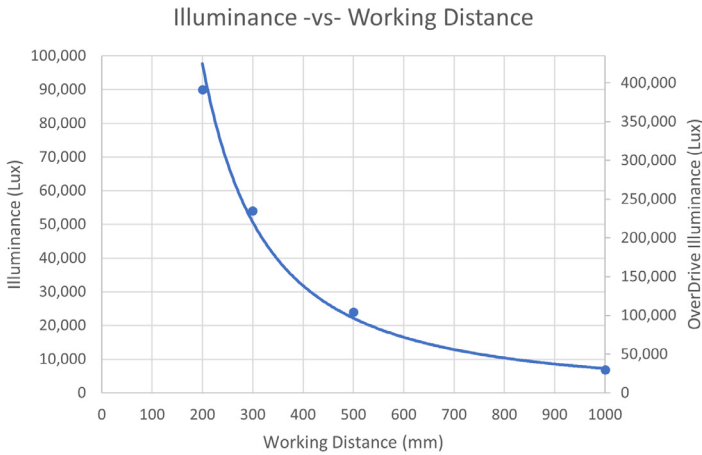

## BEAM PATTERNS

The LCZE300 is recommended to be used at a working distance between 300 mm to 2000 mm. Illuminance values taken on white light - 5700K

### Standard (10°) beam patterns

Grid set to 75 mm

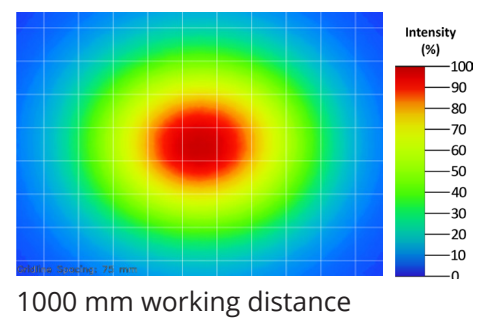
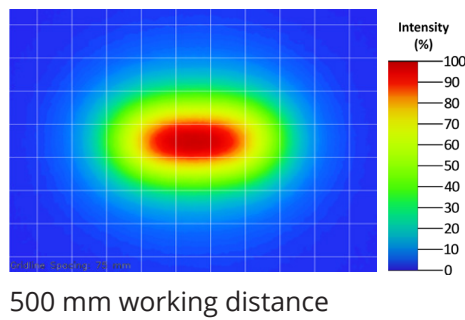
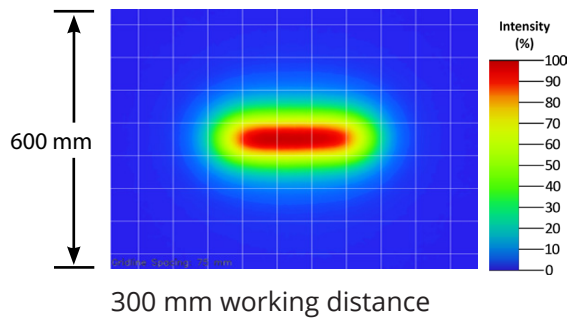

### Wide (25°) beam patterns

Grid set to 75 mm

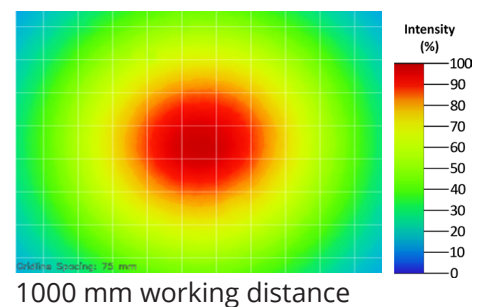
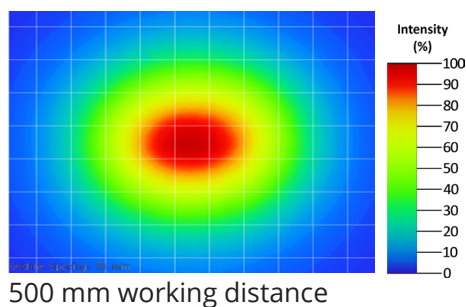
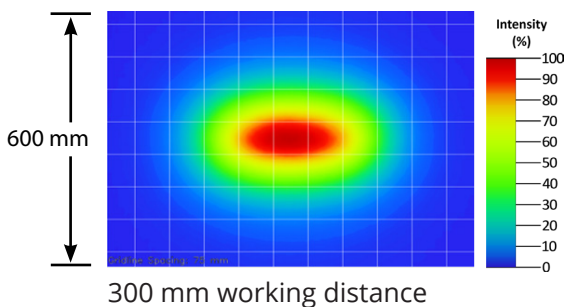

## BEAM PATTERNS (continued)

Line (10° x 50°) beam patterns  
Grid set to 75 mm

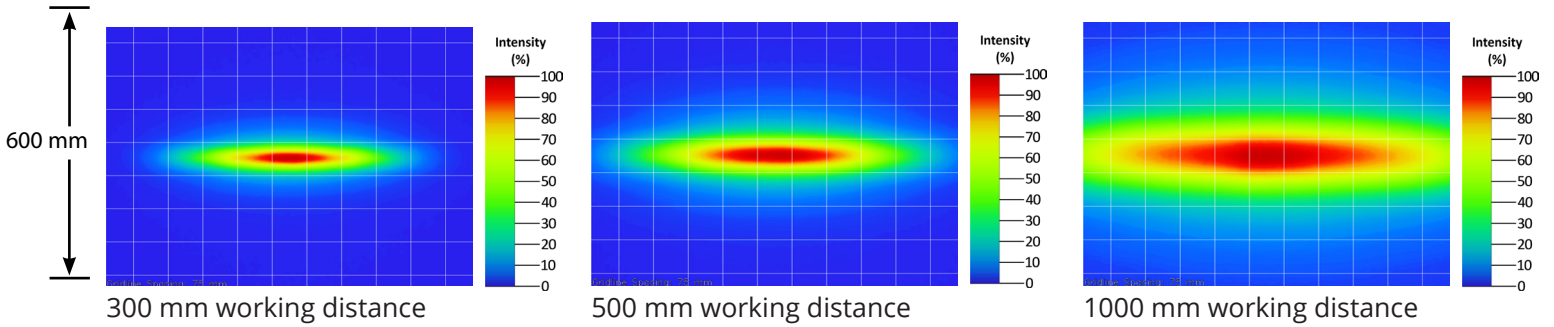

## LENS OPTICS

### NARROW (Standard)

The standard lens option uses a 10° beam angle lens. Standard lenses create a narrow beam of illumination and are used for long working distances.



### LINE

The line lens option uses a 10° x 50° beam angle lens. They project a thin, narrow beam of illumination.

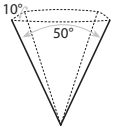

### WIDE

The wide lens option uses a 25° beam angle lens. They create a floodlight effect and can be used for short working distances.

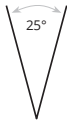

## DAISY-CHAIN LIGHTS\*

The LCZE300 daisy-chain option provides the ability to use cables to connect together two or more LCZE300 lights. The lights are able to be spaced apart from each other. Up to six LCZE300 lights can be daisy-chained together.

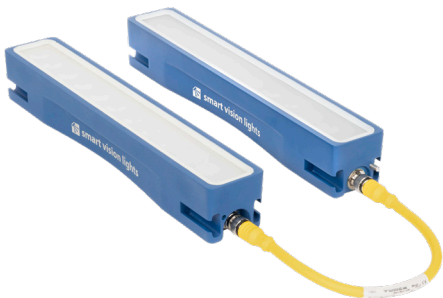

5-Pin M12 Connector (Female)

\*For this type of connection, be sure to use a -DC suffix when filling out the part number.  
Ex. LCZE300 - 625 - W25 - LPI - DC = LCZE300, 625 nm, Wide Lens (25°), Linear Polarizer Installed, Daisy Chain.  
Not compatible with direct connect or plug options.

## DIRECT CONNECT\*

The LCZE300 direct connect option provides the ability to connect lights together with no additional cables. Lights are directly connected together, with no space between the lights. Up to six LCZE300 lights can be directly connected together.

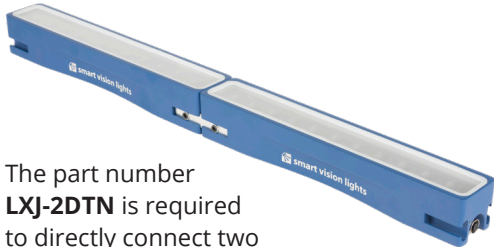

The part number **LXJ-2DTN** is required to directly connect two LCZE300 together.

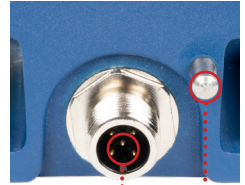

5-Pin M12 Connector (Male)

Alignment Pin



■ Part Number: LXJ-2DTN

\*For this type of connection, be sure to leave the suffix blank when filling out the part number.  
 Ex. LCZE300 - 625 - W25 - LPI = LCZE300, 625 nm, Wide Lens (25°), Linear Polarizer Installed, Direct Connect  
 Not compatible with daisy-chain or plug options.

## PLUG\*



■ Plug Connector

If multiple units are not going to be used, a plug termination can be ordered.

\*For this type of connection, be sure to use -PG when filling out the part number.  
 Ex. LCZE300 - 625 - W25 - LPI - PG = LCZE300, 625 nm, Wide Lens (25°), Linear Polarizer Installed, Plug  
 Not compatible with daisy-chain or direct connect options.

## EYE SAFETY

According to IEC 62471:2006. Full documentation available upon request with purchase of product.

### Notice

**Exempt Group:** No photobiological hazard to eyes or skin even for continuous, unrestricted use. Applicable for wavelengths 625 and 850.

### Caution

**Risk Group 1:** Possibly hazardous optical radiation emitted from this product. Do not stare at operating lamp. May be harmful to eyes. Safe for most applications except prolonged exposure. Applicable for wavelengths 470, 530, and WHI.

## ILLUMINATION

The LCZE300 works best for:

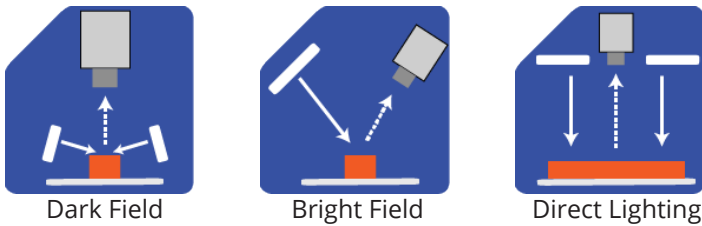

## DUTY CYCLE

**This section applies only if light is in OverDrive™ strobe mode.**

The Duty Cycle (D) is related to the Strobe Time (ST) and Rest Time (RT).

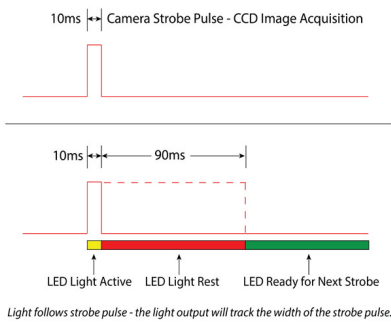

### Calculating Rest Time

$$RT = \frac{ST}{D} - ST$$

RT = Rest Time  
ST = Strobe Time  
D = Duty Cycle

#### Example

$$90 \text{ ms} = \frac{10 \text{ ms}}{.1} - 10 \text{ ms}$$

Rest Time is 90 ms for 10 ms Strobe Time

### Calculating Strobe Rate

$$SR = \frac{D}{ST}$$

SR = Strobe Rate (strokes per second)  
ST = Strobe Time (seconds)  
D = Duty Cycle

#### Example

$$1000 = \frac{0.1}{0.0001}$$

Strobe Rate is 1000 strokes per second

### Calculating Duty Cycle

$$D = ST \times SR$$

SR = Strobe Rate (strokes per second)  
ST = Strobe Time (seconds)  
D = Duty Cycle

#### Example

$$0.1 = 0.0001 \times 1000$$

Duty Cycle is 10% (0.1)

**Maximum Duty Cycle for OverDrive™ light is 10% (0.1)**

**Maximum Strobe Frequency is 1/ calculated duty cycle or 4,000 strokes per second, whichever is less.**



## MULTI-DRIVE™

Multi-Drive provides both continuous and OverDrive™ modes from a single integrated driver. Users can select the lighting mode via the input wiring configuration. With OverDrive, the light can be strobed at up to 10 times the intensity\* of continuous mode.

\*See lighting section for more information on this light's OverDrive values.



## SAFESTROBE™

SafeStrobe™ is a unique technology that applies safe working parameters to ensure high current LEDs are not damaged by driving them beyond their limits, such as maximum strobe time or duty cycle. This is especially beneficial for overdriving our high current LEDs.

## SMARTVISIONLINK™

The LCZE is SmartVisionLink™-enabled and is designed so intensity can be adjusted using the SmartVisionLink™ app\*.

SmartVisionLink™ provides a way for a light to communicate with an app on a mobile device or tablet. This technology allows users to adjust the intensity of the light in both continuous operation and OverDrive™ strobe mode. By connecting the BTM-1000 Bluetooth module to a light that is SmartVisionLink™-enabled, a user can adjust parameters for the light. The SmartVisionLink™ app is available free to download in the Apple App and Google Play Stores.

Visit [SmartVisionLights.com/SmartVisionLink](http://SmartVisionLights.com/SmartVisionLink) for more information.

\*Requires the purchase of the BTM-1000 bluetooth module, sold separately.



## CONNECTING A BTM-1000

The BTM-1000 can be connected directly to a light or attached to a jumper cable that is connected to a light. Once the light's intensity is set to a desired level, the BTM-1000 can be removed from the light or cable.

The pigtail end of the BTM-1000 is connected directly to the light or to the cable attached to the light - sold separately.



## PART NUMBER GUIDE

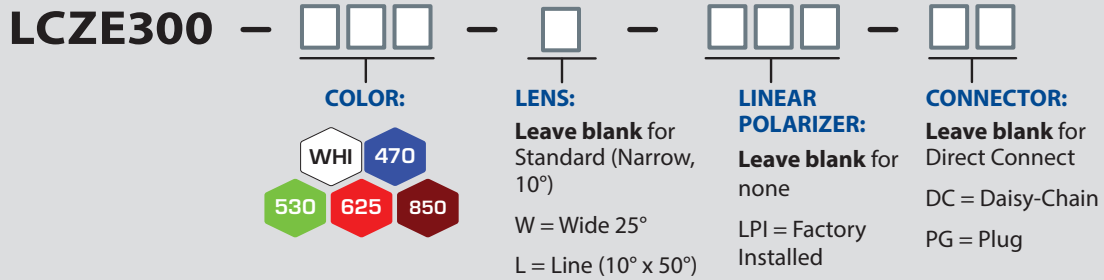

### Part Number Examples:

<b>LCZE300-625</b>	LCZE300, 625 nm Red Wavelength, Standard (Narrow 10°) Lens, Direct Connect
<b>LCZE300-WHI-W</b>	LCZE300, White, Wide Lens (25°), Direct Connect
<b>LCZE300-470-W-LPI</b>	LCZE300, 470 nm Blue Wavelength, Wide Lens (25°), Linear Polarizer Installed, Direct Connect
<b>LCZE300-470-W-LPI-DC</b>	LCZE300, 470 nm Blue Wavelength, Wide Lens (25°), Linear Polarizer Installed, Daisy-Chain

Additional wavelengths and lens options available upon request.

\*For lights with lenses, running in continuous operation while using a linear polarizer with certain wavelengths (e.g., white, blue) may burn the polarizer. Incorrect usage of the polarizer is not covered by warranty.

## ACCESSORIES

**Power Cables**

Lengths	Part Number
5 m	5PM12-5
10 m	5PM12-10
15 m	5PM12-15

**Jumper Cables (Only for Daisy Chaining)**

Lengths	Part Number
300 mm	5PM12-J300
1000 mm	5PM12-J1000
2000 mm	5PM12-J2000

**Mount**

Description	Part Number
3-Axis Pan and Tilt Mount	PB300-M5

**Replacement Mounting Screws**

Description	Part Number
Replacement Mounting Screws	SC0058

**Connector (Only for Direct Connect)**

Description	Part Number
Set of 2 Connectors	LXJ-2DTN

**SmartVisionLink™**

Part Number	Description
BTM-1000	Bluetooth Module

**Linear Polarizer**

Description	Part Number
Linear Polarizer Kit	LZE300-LP

**Variable Control Pot\***

Description	Part Number
Variable Control Pot	IVP-C1

\*Continuous mode only

## PRODUCT DRAWINGS

CAD files are available on our website. Drawings are in mm.

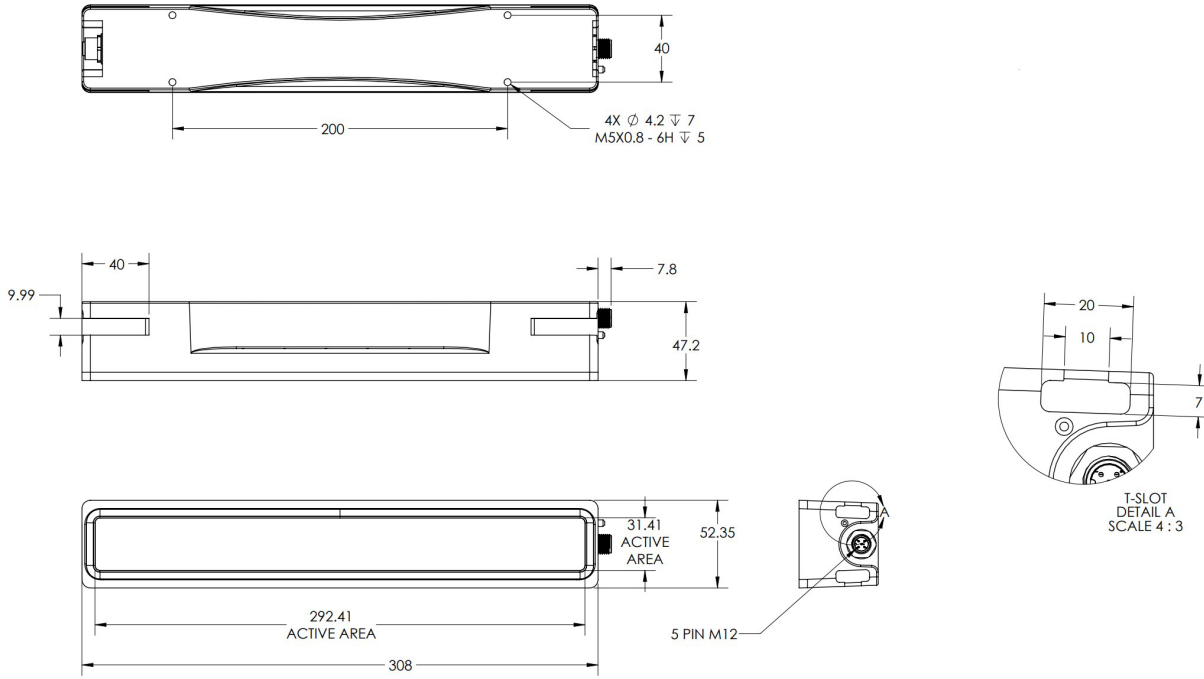

## GLOSSARY

This glossary covers all Smart Vision Lights product families; some content in this section may not apply to this specific light.

### TERMINOLOGY

**Continuous Operation** The light stays on continuously.

**OverDrive™** Integrated driver that produces a high-current strobe to the LEDs to drive them beyond their nominal continuous operation output.

**Multi-Drive™** Integrated driver that combines continuous operation and OverDrive™ strobe mode

**NanoDrive™** Integrated driver that provides fast switching where the light can go from off to on in less than 500 ns.

**Built-in Driver** The driver contained within the light that controls the current to the LEDs and provides PNP, NPN, and analog dimming controls.

**SmartVisionLink™** Integrated feature that enables lighting control through the Bluetooth module and app.

**Camera to Light** Connect the light directly to the camera, without the need for additional controllers or equipment.

**Polarizers** Filters that reduce reflections on specular surfaces.

**Diffusers** Widens the angle of emission by scattering light in all directions.

**Pattern Area Lighting** Modulated lighting pattern placed over a backlight's surface used to enhance defect detection on transparent and glossy surfaces

**SafeStrobe** Limiter to keep the light in safe working parameters.

**Direct Connect** Connect lights in a series without the use of cables.

**Daisy-Chain** Connect lights in a series with the use of cables.

### TYPES OF ILLUMINATION

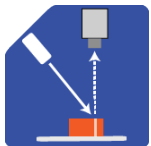

Projector

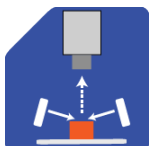

Dark Field

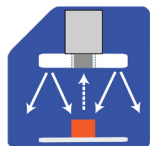

Radial

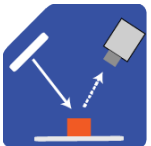

Bright Field

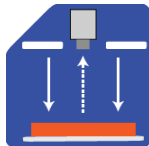

Direct

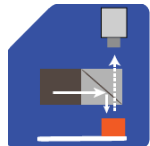

Axial

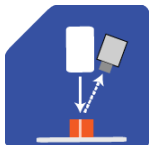

Line

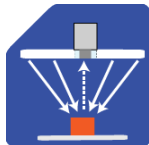

Diffuse Panel

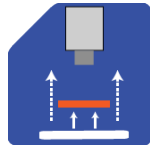

Backlight

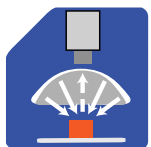

Dome  
"Light Tent"

### COMMON COLOR / WAVELENGTHS LEGEND

Wavelengths options range from 365 nm to 1650 nm.\*  
Additional wavelengths available for many light families.

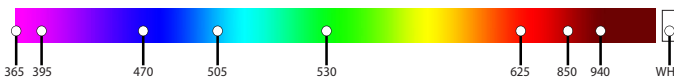

\*See Part Number section for **this light's** available standard wavelengths.



Shortwave Infrared LEDs are available in 1050 nm, 1200 nm, 1300 nm, 1450 nm, 1550 nm, and 1650 nm.\*

\*Check Part Number section to see if **this light** is available in SWIR wavelengths.



ISO 9001:2015 Certified QMS