

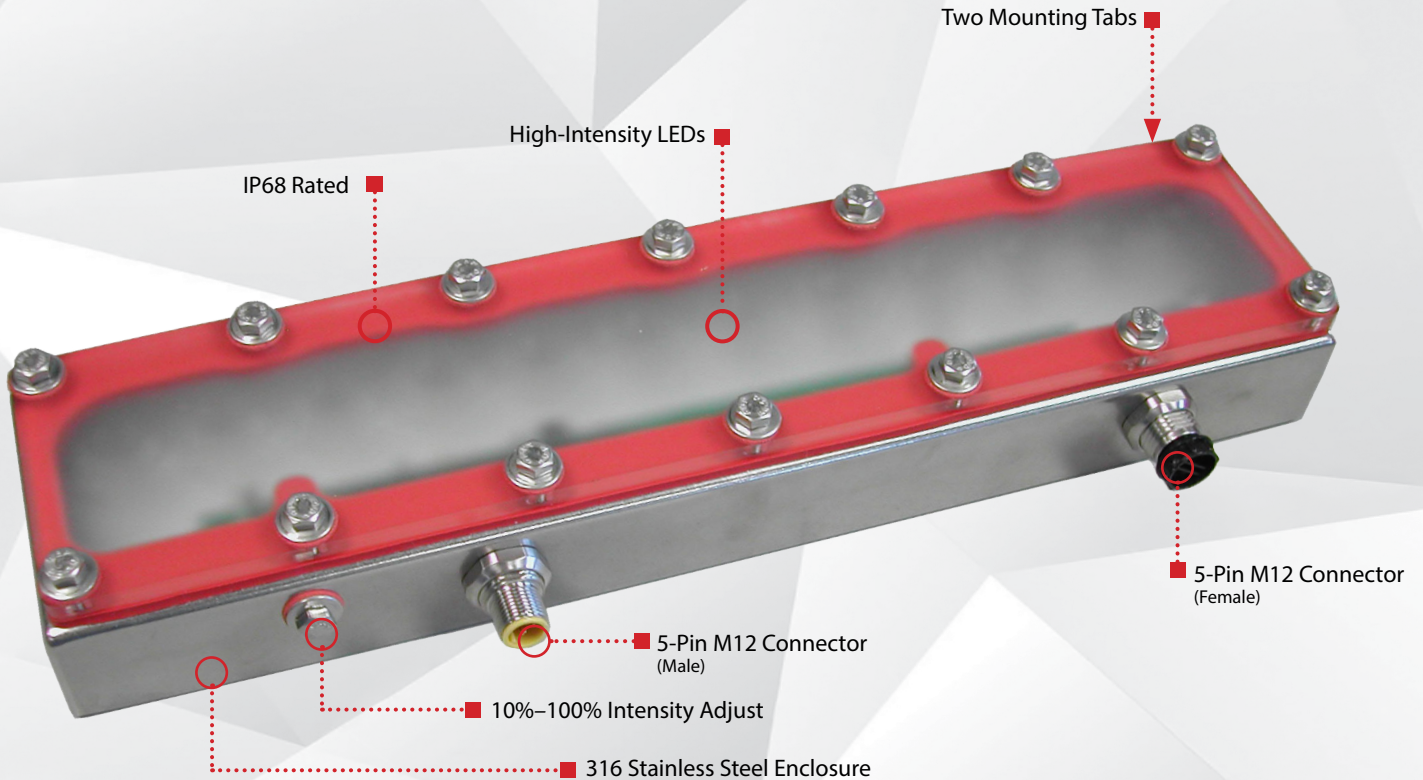

smart  
vision lights

# LW300 *Connect-a-Light* LINEAR LIGHT WASHDOWN

## P R O D U C T D A T A S H E E T



Warranty <b>10</b> YEAR	Compliant <b>IEC</b> 62471	Compliant <b>CE</b> RoHS	Rated <b>IP</b> <b>68</b>	Connector <b>5-PIN</b> <b>M12</b>
-------------------------------	----------------------------------	--------------------------------	---------------------------------	---

### PRODUCT HIGHLIGHTS

- ✓ 5-pin M12 quick connect
- ✓ Built-in driver, no external wiring needed
- ✓ PNP and NPN trigger signal input
- ✓ Washdown light with 316 stainless-steel enclosure
- ✓ Daisy-chain up to six LW300 linear lights using a 5-pin M12 washdown jumper cable



## PRODUCT DESCRIPTION

The LW300 series features a 100% waterproof stainless-steel enclosure specially designed for food industry and washdown environments where water and harsh detergents are present. The LW300 features an integrated constant-current driver built into the light and runs in continuous operation mode. NPN or PNP trigger signals can be used to control the on/off input of the light. Intensity of the light can be controlled via 1–10VDC analog signal line or the manual potentiometer. Daisy-chain up to six LW300 lights together.

## PRODUCT SPECIFICATIONS

Electrical Input	24VDC +/-5%
Input Current	Max. 700 mA
Wattage	Max. 17 W
On/Off Input	PNP: +4VDC or greater to activate   NPN: GND (<1VDC) to activate
PNP Line	4 mA @ 4VDC   10 mA @ 12VDC   20 mA @ 24VDC
NPN Line	15 mA @ Ground (0VDC)
Continuous Mode	NPN can be tied to ground <b>OR</b> PNP can be tied to 24VDC (not both)
Potentiometer	270° turn pot—Intensity control of 10%–100%. Turn clockwise to increase intensity.
Analog Intensity	Brightness output adjustable from 10%–100% via a 1–10VDC signal
Connection	5-pin M12 connector
Ambient Temperature	-18°–40°C(0°–104°F)
IP Rating	IP68
Weight	~1430 g
Compliances	CE, RoHS, IEC 62471
Warranty	UV LEDs have a 2 year warranty, all other LEDs have a 10 year warranty. For complete warranty information, visit <a href="http://smartvisionlights.com/warranty">smartvisionlights.com/warranty</a> .

## WIRING CONFIGURATION

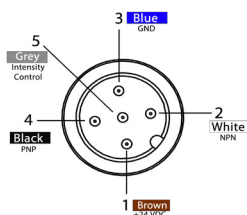

Pin layout for light (Male Connector)

Pins	Function	Signal	Wire Color
1	Power In	+24VDC	BROWN
2	NPN	Sinking Signal	WHITE
3	GND	Ground	BLUE
4	PNP	Sourcing Signal	BLACK
5	Intensity Control	1–10VDC	GREY*

\* Some cables use green/yellow for pin 5

For maximum intensity, it is possible to tie pin 5 to pin 1 at +24VDC.

For continuous mode: Tie PNP (pin 4) to +24VDC (pin 1) **or** tie NPN (pin 2) to ground (pin 3).

**OPTIONAL**

For maximum intensity, connect pin 5 to pin 1 at 24VDC.



## RESOURCE CORNER

Additional resources including CAD files, videos, and application examples, are available on our website.



## LIGHT PATTERNS

Smart Vision Lights recommends the LW300 be used at a working distance between 300 mm and 4000 mm.

Beam Diameter (White Light)—5700 K

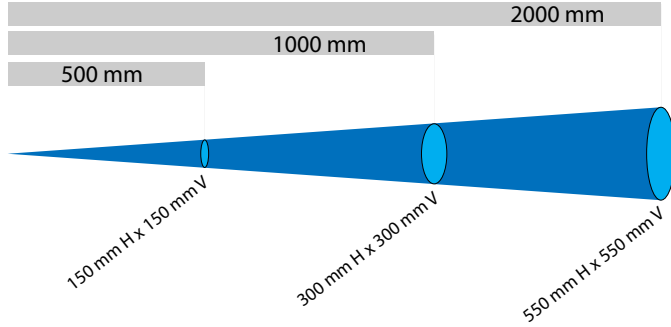

Beam Diameter (White Light)—5700 K

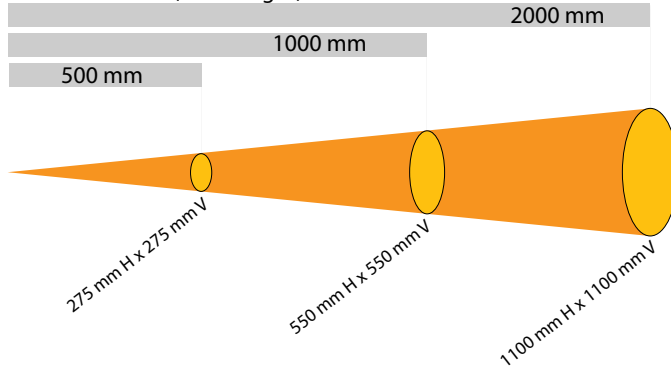

Beam Diameter (White Light)—5700 K

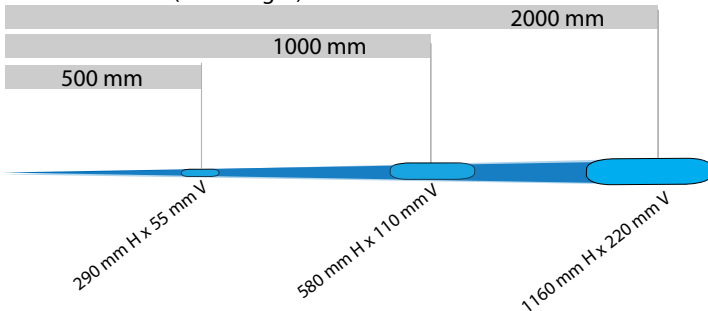

### LIGHTING PATTERN FOR THE LW300 with Narrow (Standard) Lenses

Working Distance mm (inches)	Pattern (80%–100% measured intensity) mm (inches)
500 mm (19.7")	150 mm (~5.9") H x 150 mm (~5.9") V
1000 mm (39.4")	300 mm (~11.8") H x 300 mm (~11.8") V
2000 mm (78.8")	550 mm (~21.6") H x 550 mm (~21.6") V

Typical Output Performance	Illuminance (Lux)
Distance = 500 mm	11,000
<i>Illuminance measurement taken on White Lights—5700K</i>	

### LIGHTING PATTERN FOR THE LW300 with Wide (W) Lenses

Working Distance mm (inches)	Pattern (80%–100% measured intensity) mm (inches)
500 mm (19.7")	275 mm (~10.8") H x 275 mm (~10.8") V
1000 mm (39.4")	550 mm (~21.6") H x 550 mm (~21.6") V
2000 mm (78.8")	1100 mm (~43") H x 1100 mm (~43") V

Typical Output Performance	Illuminance (Lux)
Distance = 500 mm	8000
<i>Illuminance measurement taken on White Lights—5700K</i>	

### LIGHTING PATTERN FOR THE LW300 with Line (L) Lenses

Working Distance mm (inches)	Pattern (80%–100% measured intensity) mm (inches)
500 mm (19.7")	290 mm (~12.2") H x 55 mm (~2.1") V
1000 mm (39.4")	580 mm (~24.4") H x 110 mm (~4.3") V
2000 mm (78.8")	1160 mm (~48.8") H x 220 mm (~8.6") V

Typical Output Performance	Illuminance (Lux)
Distance = 500 mm	19,000
<i>Illuminance measurement taken on White Lights — 5700K</i>	

The LW300 Linear Light produces a uniform light pattern.

Working Distance = 500 mm Grid set to 25 mm x 25 mm

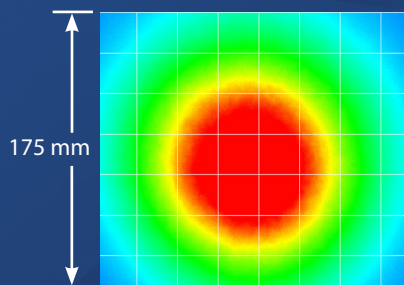

Narrow

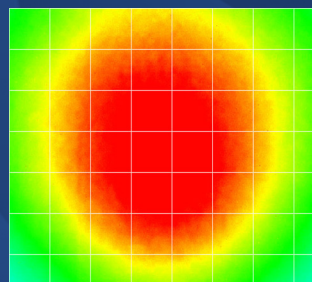

Wide

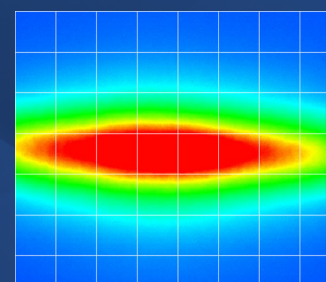

Line





## DAISY-CHAIN LIGHTS

LW300 series of lights require the use of a 5-pin M12 jumper cable to effectively parallel up to six LW300 lights.



## PRODUCT DRAWING

CAD files available on our website.  
Dimensions are in mm.

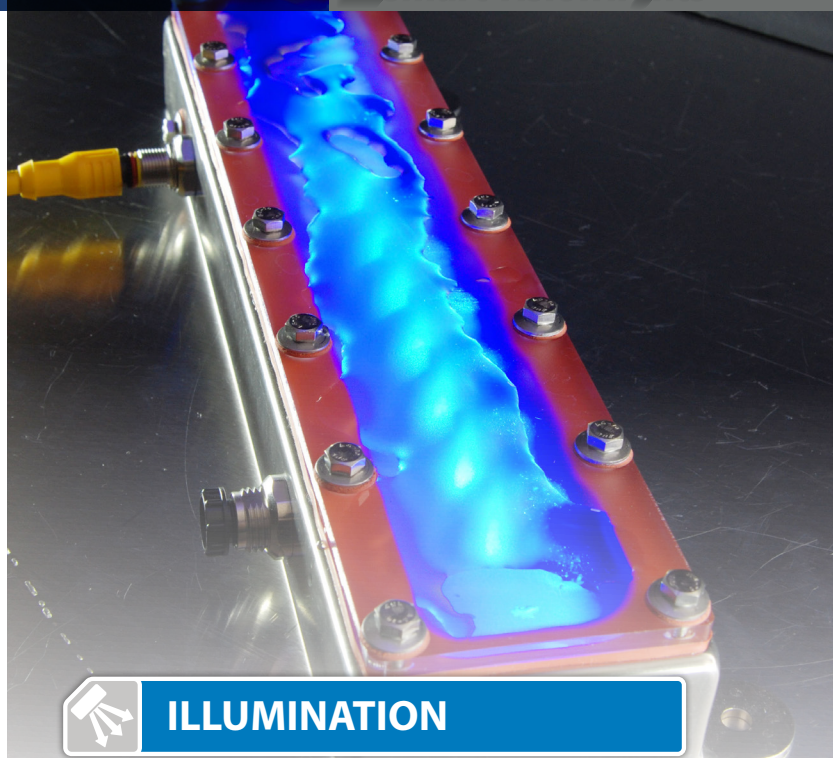
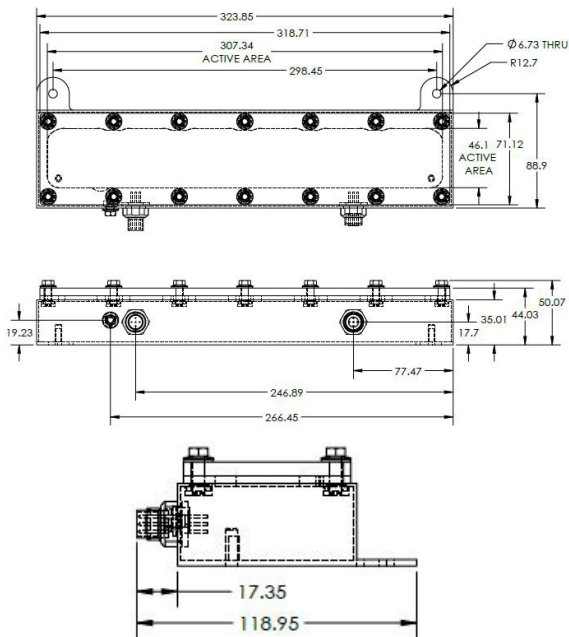

## ILLUMINATION

LW300 Series of Linear Lights works best for:

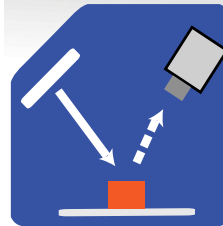

Bright Field

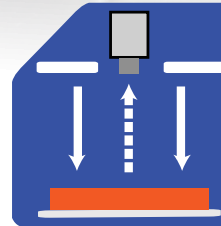

Direct Lighting

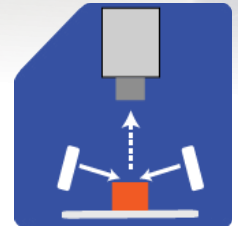

Dark Field



## EYE SAFETY



According to IEC 62471:2006. Full documentation available upon request with purchase of product.

### Notice

**Exempt Group:** No photobiological hazard to eyes or skin even for continuous, unrestricted use. Applicable for wavelengths 625, 850, and 940.

### Caution

**Risk Group 1:** Possibly hazardous optical radiation emitted from this product. Do not stare at operating lamp. May be harmful to eyes. Safe for most applications except prolonged exposure. Applicable for wavelengths 470, 505, 530, and WHI.

### Caution

**Risk Group 2:** UV emitted from this product. Eye or skin irritation may result from exposure. Use appropriate shielding. Does not pose optical hazard if aversion responses limit exposure. Applicable for wavelengths 365 and 395.





## PART NUMBER

**LW300**



**COLOR:**



**LENS:**

Leave blank for Standard (Narrow)

W = Wide

L = Line



**LINEAR POLARIZER:**

Leave blank for none

LPI = Factory Installed

### Part Number Examples:

**LW300-625** LW300, 625 nm Red Wavelength, Standard (Narrow) Lens

**LW300-WHI-L** LW300, White, Line Lens

**LW300-470-W-LPI** LW300, 470 nm Blue Wavelength, Wide Lens, with Linear Polarizer Installed

*Line lens optic not available for UV wavelengths.  
Additional wavelengths and lens options available upon request.*



## STANDARD LENS OPTICS

### NARROW (STANDARD)

Narrow, 14° angle-cone lenses are standard. Standard lenses create a narrow beam of illumination and are used for long working distances.



### WIDE

Wide, 30° angle-cone lenses create a large area of illumination. They create a floodlight effect, can be used for short working distances.



### LINE

Line, with a 10° width and a 50° fan angle projects a thin, narrow beam of illumination.

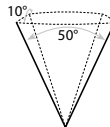

*\* Additional lens options available upon request.*



## MOUNTING

The LW300 Series features two stainless-steel tabs welded directly to the housing for simple yet versatile mounting options.



### When to Use a Linear Polarizers?

Polarizing filters can reduce reflections on specular (Dielectric or non-metal) surfaces.

A Linear Polarizer has a typical transmission of 38 percent while blocking 62 percent of the light not in the polarization plane.

**WARNING:** Running a light in continuous operation while using a standard polarizer with certain wavelengths (ex. white, blue) may result in burning of the polarizer.



## ACCESSORIES

### Power Cables (Washdown)



Length	Part Number
5 m	W5PM12-5
10 m	W5PM12-10
15 m	W5PM12-15

### Jumper Cables (Daisy-Chain, Washdown)



Length	Part Number
300 mm	W5PM12-J300
2000 mm	W5PM12-J2000

Washdown cables have a 316 stainless-steel connector(s).



## GLOSSARY

This glossary covers all Smart Vision Lights product families; some content in this section may not apply to this specific light.

### TERMINOLOGY

**OverDrive™** Lights include an integrated high-pulse driver for complete LED light control.

**Continuous Operation** Lights stay on continuously.

**Multi-Drive™** Combines continuous operation and OverDrive™ strobe (high-pulse operation) mode into one easy-to-use light.

**Built In Driver** The built-in driver allows full function without the need for an external controller.

**Camera to Light** Connect the light directly to the camera, without the need for additional controllers or equipment.

**Polarizers** Filters that reduce reflections on specular surfaces.

**Diffuser** Used to widen the angle of light emission, reduce reflections, and increase uniformity.

### TYPES OF ILLUMINATIONS

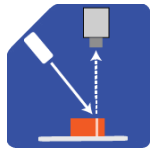

Projector

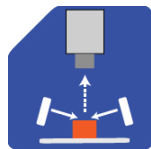

Dark Field

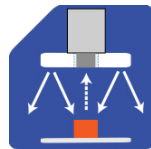

Radial



Bright Field

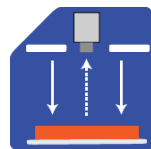

Direct

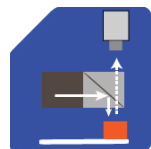

Axial

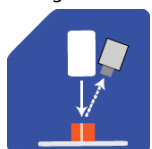

Line

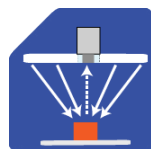

Diffuse Panel

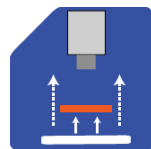

Backlight

### COLOR/WAVELENGTHS LEGEND

Wavelength options range from 365 nm to 1550 nm.\*  
Additional wavelengths available for many light families.

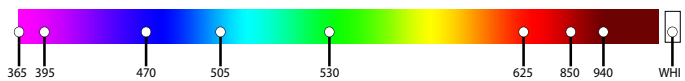

\*See Part Number section for **this light's** available standard wavelengths.



Shortwave infrared LEDs are available in 1050 nm, 1200 nm, 1300 nm, 1450 nm, and 1550 nm.

\*Check Part Number section to see if **this light** is available in SWIR wavelengths.