

P R O D U C T D A T A S H E E T

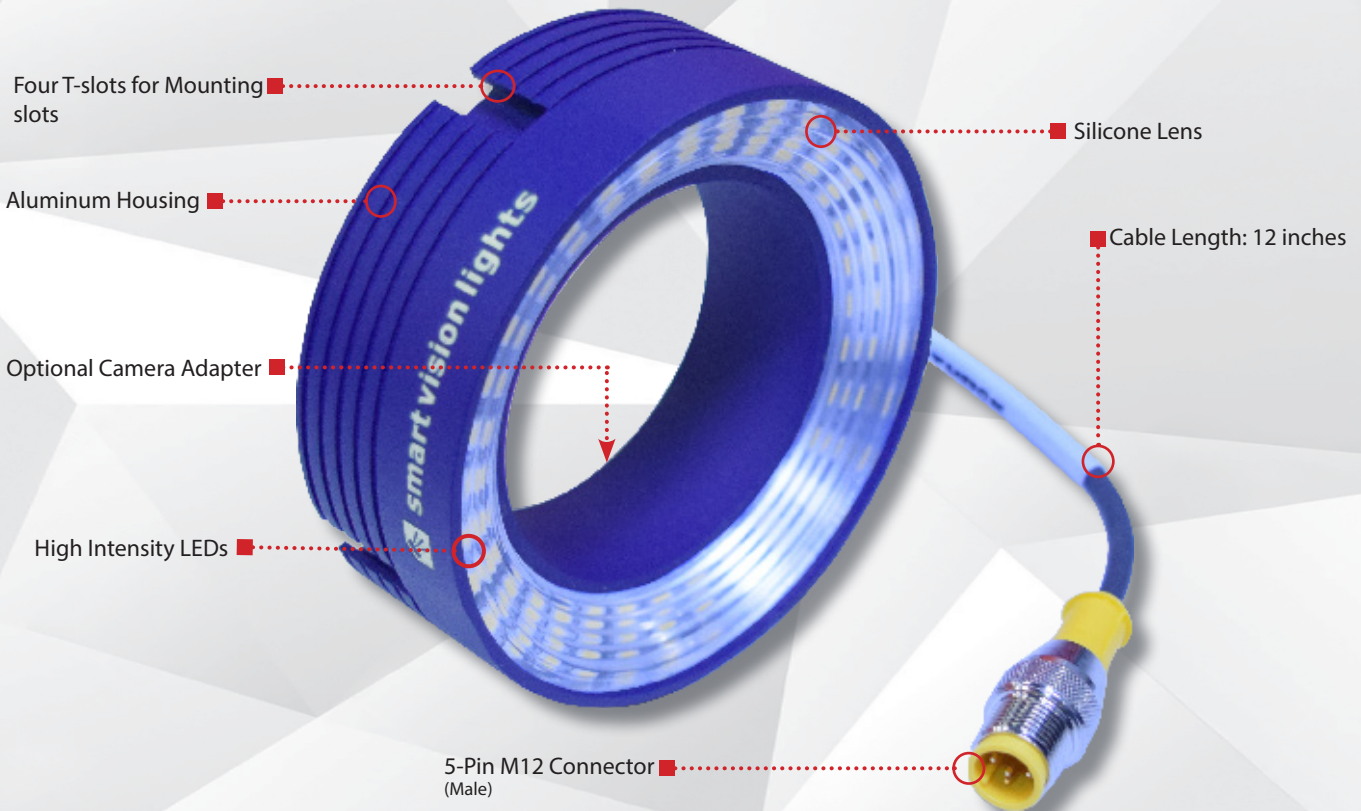

Warranty
10
YEAR

Compliant
IEC
62471

Compliant
CE
RoHS

Rated
IP
65

Connector
5-PIN
M12

PRODUCT HIGHLIGHTS

- ✓ Built-in Multi-Drive™ allows the light to work in continuous operation or OverDrive™ mode
- ✓ Built-in driver, no external wiring needed
- ✓ PNP and NPN strobe input
- ✓ SafeStrobe™ technology
- ✓ 5-pin M12 quick connect





PRODUCT DESCRIPTION

The built-in driver on the RMX75 Series features Multi-Drive™, which allows the user to operate the light in constant operation or OverDrive™ depending on the wiring method. The industry-standard 5-pin M12 connector makes for simple wiring. The 1–10 V analog control line gives the user total control over intensity in continuous operation mode. Grounding the signal will put the light into OverDrive™ mode.



PRODUCT SPECIFICATIONS

	CONTINUOUS OPERATION	OVERDRIVE™ STROBE MODE
Electrical Input	24 V DC +/- 5%	
Input Current	Max. 290 mA	Max. 2.5 A
Wattage	Max. 7.0 W	Max. 60 W
PNP Line	4 mA @ 4 V DC 10 mA @ 12 V DC 20 mA @ 24 V DC	
NPN Line	15 mA @ Ground (0 V DC)	
OverDrive™ Strobe Mode	Not applicable	Connect pin 5 to GND (see Wiring Configuration for more information)
Strobe Duration	Not applicable	Min. 10 μ s Max. 50 ms (see SafeStrobe™ Technology for more information)
Duty Cycle	Not applicable	Max. 10%
Strobe Input	Not applicable	PNP: +4 V DC or greater to activate NPN: GND (<1 V DC) to activate
Continuous Operation Mode	NPN can be tied to ground OR PNP can be tied to 24 V DC (not both)	Not applicable
On/Off Input	PNP: +4 V DC or greater to activate NPN: GND (<1 V DC) to activate	Not applicable
Connection	5-pin M12 connector	
Ambient Temperature	-18°–50° C (0°–122° F)	
IP Rating	IP65	
Weight	120 g	
Compliances	CE, RoHS, IEC 62471	



PRODUCT DRAWING

CAD files available on our website.
Dimensions are in mm.

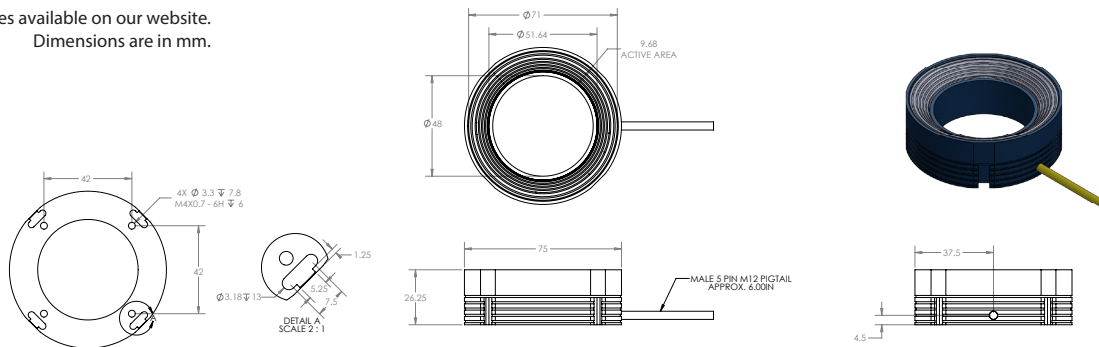

RESOURCE CORNER

Additional resources are available on our website, including CAD files, videos, and application examples.



WIRING CONFIGURATION

CONTINUOUS OPERATION MODE

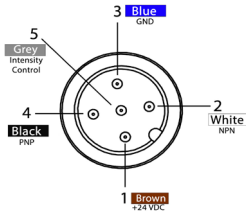

Pin layout for light (male connector)

Pins	Function	Signal	Wire Color
1	Power In	+24 V DC	BROWN
2	NPN	Sinking Signal	WHITE
3	GND	Ground	BLUE
4	PNP	Sourcing Signal	BLACK
5	Intensity Control	1-10 V DC	GREY*

* Some cables use green/yellow for pin 5
 For maximum intensity, it is possible to tie pin 5 to pin 1 at +24 V DC.
 For continuous mode: PNP (pin 4) can be tied to +24 V DC (pin 1) or NPN (pin 2) can be tied to Ground (pin 3).

For the light to function properly, apply either a PNP or NPN signal, not both.

Failure to supply light with correct input current will result in nonrepeatable lighting
 (see Product Specifications for requirements)

OVERDRIVE™ OPERATION MODE

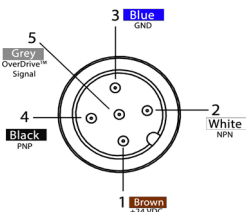

Pin layout for light (male connector)

Pins	Function	Signal	Wire Color
1	Power In	+24 V DC	BROWN
2	NPN	Sinking Signal	WHITE
3	GND	Ground	BLUE
4	PNP	Sourcing Signal	BLACK
5	OverDrive™ Signal	Ground	GREY*

* Some cables use green/yellow for pin 5

Failure to supply light with correct input current will result in nonrepeatable lighting
 (see Product Specifications for requirements)



LIGHT PATTERNS

Smart Vision Lights recommends the RMX75 be used at a working distance between 100 mm and 500 mm.

LIGHTING ILLUMINATION FOR THE RMX75

Continuous Operation Mode	
Typical Output Performance	Illumination (Lux)
Distance = 200 mm	4100
<i>Illumination measurement taken on White Light — 4800 K</i>	

OverDrive™ Mode	
Typical Output Performance	Illumination (Lux)
Distance = 200 mm	41,000
<i>Illumination measurement taken on White Light — 4800 K</i>	

The RMX75 Mini Ring Light produces a uniform light pattern.

WD = Working Distance

Grid set to 25 mm x 25 mm

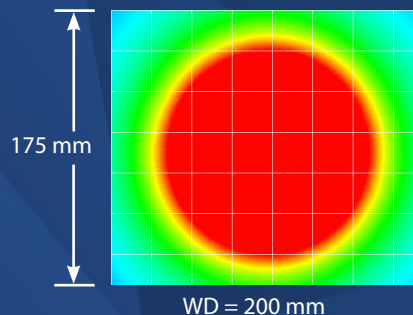

MULTI-DRIVE™

Multi-Drive™ offers the best of both worlds. Continuous operation and OverDrive™ mode (HIGH output strobe/pulse) are available in a single light. Other advantages of Multi-Drive™ include faster imaging and capture/freeze motion on high-speed lines.



The Multi-Drive™ feature allows the user to run the light continuously or in OverDrive™ at the maximum allowed intensity by simply setting the product configuration. OverDrive™ operation has **up to 10 times** the power of continuous operation.

SAFESTROBE™ TECHNOLOGY

SafeStrobe™ technology is a unique technology that applies safe working parameters to ensure high current LED's are not damaged by driving them beyond their limits, such as maximum strobe time or duty cycle. This is especially beneficial for overdriving our high current LED's.

DUTY CYCLE (OVERDRIVE™ MODE ONLY)

This section applies only if light is in OverDrive™ Mode.

The Duty Cycle (D) is related to the Strobe Time (ST) and Rest Time (RT).

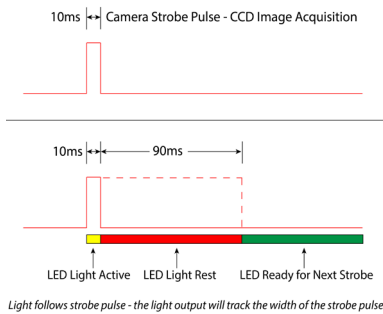

Calculating Rest Time

$$RT = \frac{ST}{D} - ST$$

RT = Rest Time
ST = Strobe Time
D = Duty Cycle

Example

$$RT = \frac{10 \text{ ms}}{.1} - 10 \text{ ms} = 90 \text{ ms}$$

Rest Time is 90 ms for 10 ms Strobe Time

Maximum Duty Cycle for OverDrive™ light is 10% (0.1)

EYE SAFETY

According to IEC 62471: 2006. Full documentation available upon request.



Notice

Exempt Group: No photobiological hazard to eyes or skin even for continuous, unrestricted use. Applicable for wavelengths: 625.

Caution

Risk Group 1: Possibly hazardous optical radiation emitted from this product. Do not stare at operating lamp. May be harmful to eyes. Safe for most applications except prolonged exposure. Applicable for wavelengths: 470, 530, and WHI.

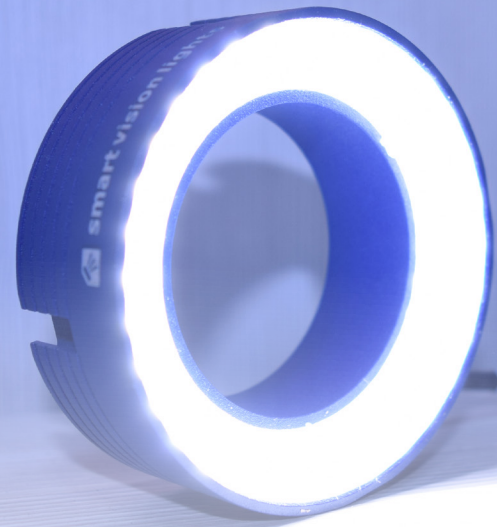

ILLUMINATION

RMX75 Series of Miniature "Mini" Ring Lights works best for:

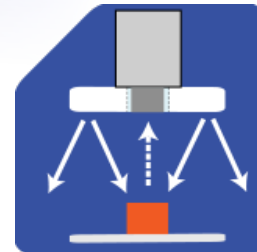

Radial



PART NUMBER

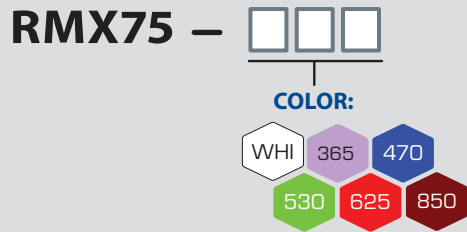

Part Number Examples:
RMX75-625 (RMX75, 625 nm Red Wavelength)

Additional wavelengths available upon request



MOUNTING

Mounting options include four (4) T-slots and four (4) M4 threaded holes on the RMX75 mini ring light.

Hardware included with light:

- (2) M4 x 8 mm screws (Hex)
- (2) M5 x 10 mm screws (Hex)
- (2) M5 T-nuts



Optional Camera Mounts

Easily mount your camera with RMX75 attached to any fixture using one of these brackets:



BKT0004



PB30-M10

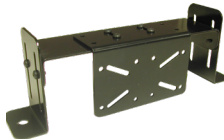

BKT0006

Optional Camera Mounting Adapter	
	<p>The optional ADP0001-KIT can be used to mount a camera or lens directly to the RMX75.</p>



CAMERA MOUNTING ADAPTER

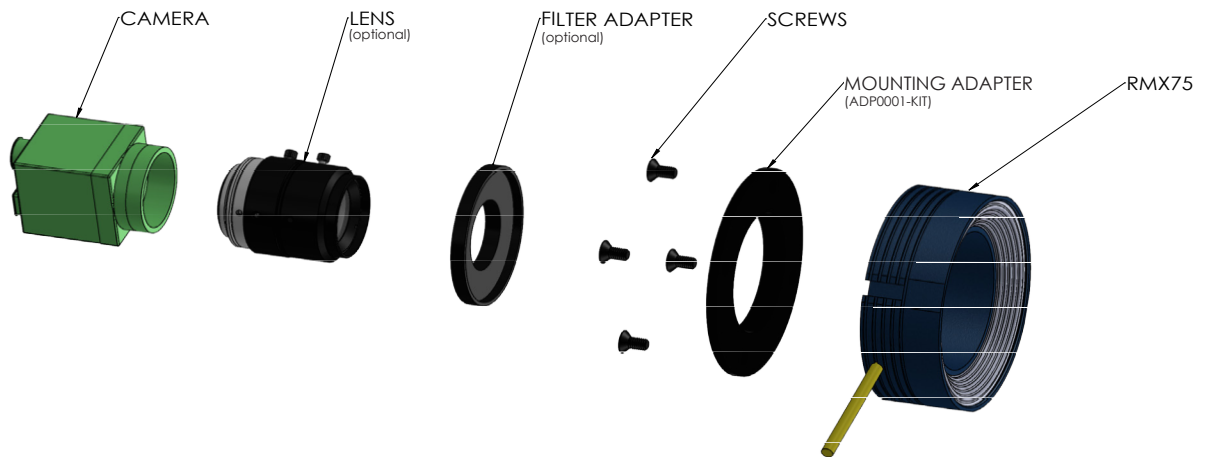



ACCESSORIES

Step-Up Kits *



Lens Thread Size	Part Number
25 mm	SU25.5-46
27 mm	SU27-46
30.5 mm	SU30.5-46
34 mm	SU34-46
35.5 mm	SU35.5-46
37 mm	SU37-46
39 mm	SU39-46
40.5 mm	SU40.5-46
43 mm	SU46-46

Step-Down Kits



Lens Thread Size	Part Number
49 mm	SD49-46
52 mm	SD52-46
55 mm	SD55-46
58 mm	SD58-46
62 mm	SD62-46
67 mm	SD67-46
72 mm	SD72-46

Power Cables



Lengths	Part Number
5 m	5PM12-5
10 m	5PM12-10
15 m	5PM12-15

Camera Adapter



Description	Part Number
Camera Adapter	DF34.9-46
Camera Adapter	DF55-46
Camera Adapter	DF60-46
Camera Adapter	DF60.75-46

Camera Mounting Adapter



Description	Part Number
Adapter	ADP0001-KIT

Power Adapters *



Description	Part Number
AC, 24 Volt, 1.7 Amp	T1 Power Supply

* **European Versions Available** (Add -EURO to end of T1 or T2. Example T1-EURO Power Supply)

T1 Power Supply is **only recommended** when using light in continuous operation.



GLOSSARY

This glossary covers all Smart Vision Lights product families; some content in this section may not apply to this specific light.

TERMINOLOGY

OverDrive™ Lights include an integrated high-pulse driver for complete LED light control.

Continuous Operation Light stay on continuously.

Multi-Drive™ Combines continuous operation and OverDrive™ strobe (high-pulse operation) modes into one easy-to-use light.

Built-in Driver The built-in driver allows full function without the need of an external controller.

Camera to Light Connecting the light directly to the camera, without the need for additional controllers or equipment.

Polarizers Filters that reduce reflections on specular surfaces.

Diffuser Used to widen the angle of light emission, reduce reflections, and increase uniformity.

TYPES OF ILLUMINATIONS

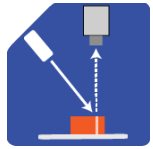

Projector

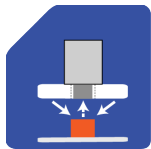

Dark Field

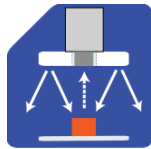

Radial



Bright Field

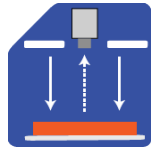

Direct

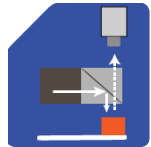

Axial

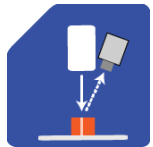

Line

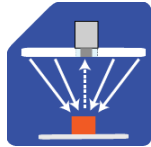

Diffuse Panel

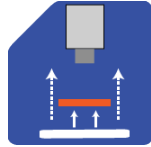

Backlight

COMMON COLOR/WAVELENGTHS LEGEND

Wavelengths options range from 365 nm to 1550 nm.*

Additional wavelengths available for many light families.

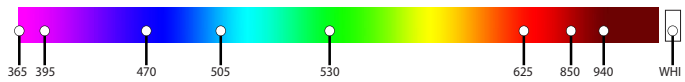

*See Part Number section for **this light's** available standard wavelengths.



Short Wave Infrared LEDs are available in 1050 nm, 1200 nm, 1300 nm, 1450 nm, and 1550 nm.