

TX Series Backlight

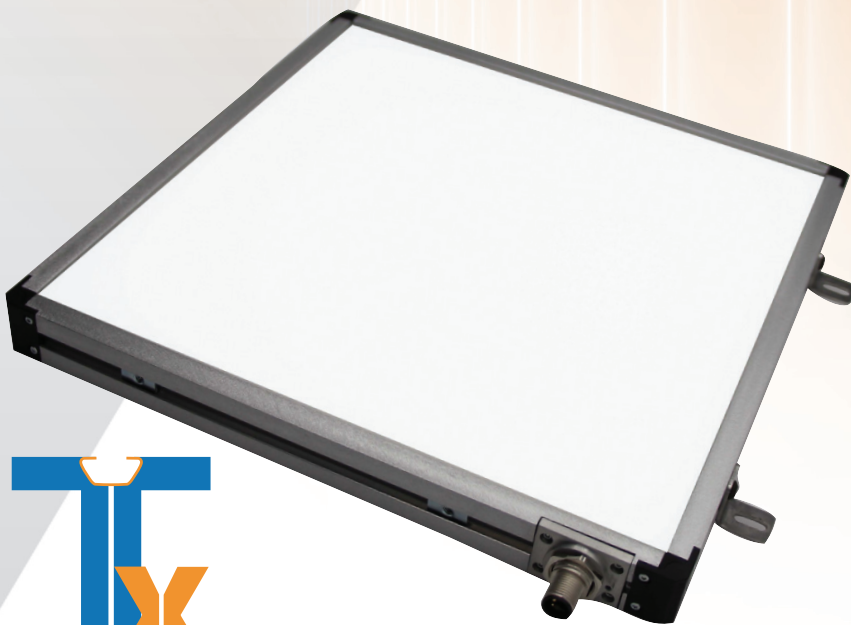

Advanced Performance for Machine Vision
Inspection, Measurement, and Gauging

The TX Back Light Difference

The TX Series of Back Lights provides superior performance for the most demanding machine vision applications.

The latest High Density Precision Chip Technology (HDPCT) produces impressive intensity and uniformity across the full array (edge-to-edge). State-of-the-art driver technology delivers instant start-up and flicker-free operation. Optimize your application, maintain flexibility and minimize technical risk with the exceptional results obtained from the TX Series Back Lights from Metaphase Lighting Technologies.

- ✓ **Best for high-contrast, high-accuracy** inspection, measurement and gauging applications.
- ✓ **Low-profile housing with 10mm bezel**, ideal for space-limited applications.
- ✓ **Maximum installation flexibility** with 180-degree adjustable T-slot L-brackets (included).
- ✓ **High-uniformity and brightness** provided by a full array of high-density LEDs.
- ✓ **Application flexibility** with six available wavelengths (R,G,B, W, IR850, IR940).
- ✓ **Multispectral: 35 possible combinations** by selecting up to four colors.

Features

- 4-sided T-slot based aluminum extrusion. T-nuts supplied. (M4-0.7p x 6mm hex key head).
- Ultra-Slim 10mm housing bezel, maximizes active area relative to footprint.
- Compact 25mm height, available with either internal (-DC) driver or external (-U) drivers (with over-driving strobe).
- External Trigger Included.
- Bulkhead 5-pin M12 A-code connector(s) for DC version, 4-pin M12 T-code for external driver version.
- Built-in high-efficiency, dimmable, constant current driver (DC Version).
- Optional polarizer filter is a simple field replace/retrofit.

Ordering Info

TXBL/ TXCBL Part Numbers and Sizes

TXBL available in 25mm (1 in nominal) increments, up to 1000x1000 mm



TX Series
Back Light



TABLE 1: PART NUMBER KEY

Contact your Metaphase Sales representative for custom versions (intensity, uniformity, wavelengths, sizes, etc).

| Family | Active Area (1 unit = 25mm) | Wavelength | Drive | Polarizer | Connector Location |
|-----------------------|---------------------------------------|-----------------------------------|--------------------------------------|-----------------------|---|
| TXBL TXCBL | XXXX (small dimension first) | XXXXXX | XX | XXXXX | Blank if No Modification |
| TXBL | 0202-1640 | W (White 5700K, Nominal) | DC (24VDC) | Blank if no polarizer | Long-side, right is the default M12 location. Contact Metaphase for other M12 locations. |
| TXCBL (Collimated) | 0202-1616 | B (Blue 470nm) | U (Universal LED Controller, ULC) | POL0 | |
| | | G (Green 530nm) | | POL90 | |
| | | R (Red 630nm) | | | |
| | | IR850 (Infrared 850nm) | | | |
| | | RGB (630nm, 520nm, 470nm) | | | |
| | | RGBW (630nm, 520nm, 470nm, 5700K) | | | |
| | | WIR850 (850nm, 5700K) | | | |
| | | WIR940 (940nm, 5700K) | | | |

Example 1: TXBL0412-R-DC

Back Light – 100mm x 300mm – Red – DC Operation – No Modification

Example 2: TXCBL1016-WIR850-DC-SSL

Collimated Back Light – 250mm x 400mm – White and IR850 – DC Operation, Short Side Left connector location – No Modification

| Accessories | Part Number | Description |
|-------------------|---------------------------------|---|
| DC Version | | |
| DDC Controller | DDC-3 | DIGITAL DIMMING CONTROLLER, 3-CHAN 0-10V OUTPUT <i>Note: Requires 24VDC, 1A power supply</i> |
| 3m cable | CAB-FM12FL-3M | 3 METER EXTENSION CABLE, FEMALE M-12 A-CODE 5-PIN TO FLYING LEADS |
| 5m cable | CAB-FM12FL-5M | 5 METER EXTENSION CABLE, FEMALE M-12 A-CODE 5-PIN TO FLYING LEADS |
| 10m cable | CAB-FM12FL-10M | 10 METER EXTENSION CABLE, FEMALE M-12 A-CODE 5-PIN TO FLYING LEADS |
| U Version | | |
| ULC-2 Controller | ULC-2 | UNIVERSAL LED CONTROLLER, TWO-CHANNEL, WITH ULC-2 CONNECTORS <i>Note: Requires 24VDC power supply, 6.7A, to run at full capability</i> |
| 3m cable | CAB-FM12TU-3M - For 1 channel | 3 METER EXTENSION CABLE, FEMALE M12 T-CODE 4-PIN TO ONE ULC CONNECTOR, LED POS ON PIN 1&2, LED NEG ON PINS 3&4 |
| 3m cable | CAB-FM12T2U-3M - For 2 channels | 3 METER EXTENSION CABLE, FEMALE M12 T-CODE 4-PIN TO TWO ULC CONNECTOR, LED POS CHAN A&B ON PINS 1&2, LED NEG CHAN A&B ON PINS 3&4 |

Available Wavelengths

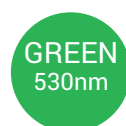

*Note:
Available in
many more color
combinations*



| General | |
|--|---|
| Operating Temperature | 0-40°C, 90% RH, non-condensing* |
| IP Rating | IP50 |
| Storage Temperature | 0-70°C, 90% RH, non-condensing |
| Compliance | RoHs, CE, IEC 61000-6-2, 61000-6-4, 61010-1 |
| Photobiological Risk Factor** | Exempt |
| Warranty | 2 Years |
| * Contact your Metaphase sales engineer for higher temperature environments. | |
| **Full documentation available upon request. | |
| Electrical | |
| Supply Voltage | 24VDC+/-5% |
| DC Version (-DC) | |
| 0-10V Dimming Control (TXBL TXCBL) | Off: 0V Turn-on Threshold: 0.9V 100% Intensity: 10V <i>Note: 0-10V Must be connected to turn light on and to trigger.</i> |
| | Maximum allowance voltage: 10V-24V |
| Input Impedance | ≥180kΩ/1300 cm ² increment, per wavelength |
| External Controller Version (-U) | |
| Forward Voltage (DC mode) | W: 11.2VDC Red: 7.2VDC Green: 11.6VDC Blue: 11.2VDC IR850 or IR940: 5.2VDC |
| Trigger Input: | |
| Min Trigger Pulse = 2.5µs | PNP (See Figure 1) |
| Max trigger rate = 5 kHz | Voltage Enable > 1.39V |
| Trigger turn-on delay = 51µs | Voltage Disable < .56V |
| Trigger turn-off delay = 5µs | NPN (See Figure 2) |
| | Input Impedance = 10kΩ |
| <i>Note : For continuously ON @ full intensity connect 24VDC power supply to +24V, 0-10VDC and PNP trigger-in inputs</i> | |
| Optical | |
| Light Source | LED |
| LED Array Density | High Density Precision Chip Technology (HDPCT) |
| Available Wavelengths | 470, 530, 630, 850, 940 |
| Intensity | W - 86,000 Lux, R - 79,000 Lux, G - 79,000 Lux, B - 12,000 Lux |
| Available Color Combinations | W(5700K), RGB, RGBW, WIR850 (5700K/850), WIR940 (5700K/940) |
| Lifetime | L70 = 75,000 hours |
| Polarizer (Optional and field-installable by removing one side rail with T6 wrench) | |

Mechanical (all units metric)

Housing 25mm profile with 10mm bezel, made of clear anodized aluminum

Mounting
(2) T-nuts minimum per side, pre-installed

Outside Dimensions (OD)
OD = Active Area + 20mm (see Figure 12)

Active Area Designation
Part Number "TXBLXXYY" indicates the Active Area is "Ax" by "Ay"
See Table 1 "Part Number Key"

L-Bracket Mounting
Center-to-center mounting hole distance = Active Area + 40mm (see Figure 13)

Fasteners M4-0.7px6mm hex key head

Weight (kg/mm²) See Table 6: "Weight (kg) for Active Area Width and Length"

Bulkhead Male M12
See Table 4: "Max Current Draw and Number of Connectors per Size (-DC Version)"
Note: "Long Side Right" is default location.

TXBL/ TXCBL M12A Connector, DC version



M12A Bulkhead, 5-pos male TXBL Interface
Cable with M12A female connector

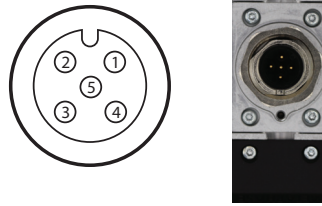
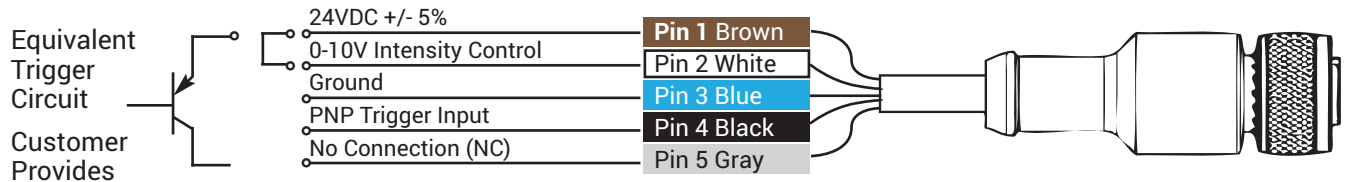
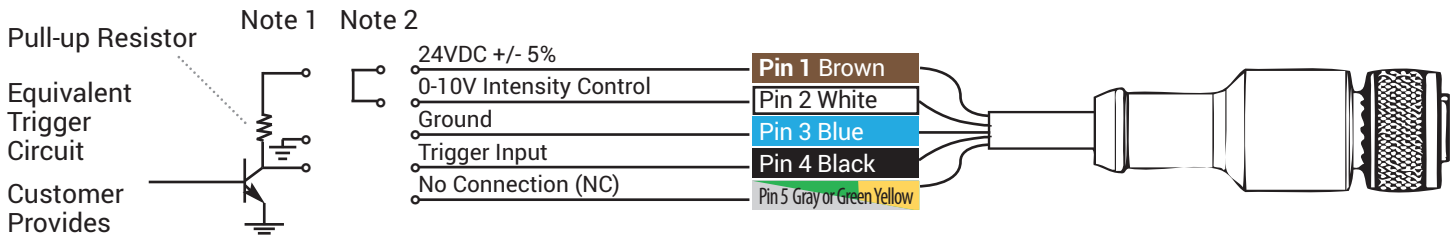

FIGURE 1: TXBL INTERFACE CABLE, M12 5-PIN A-CODE FEMALE CONNECTOR, CONFIGURED FOR PNP TRIGGER



Note: For continuously ON @ full intensity connect 24VDC power supply to +24V , 0-10VDC and PNP trigger-in inputs.

FIGURE 2: TXBL INTERFACE CABLE, M12 5-PIN A-CODE FEMALE CONNECTOR, CONFIGURED FOR NPN TRIGGER



Note 1 for NPN Trigger Input: Connect 47kΩ ohm or less between 24VDC and Trig NPN pulls down below .5V to DISABLE light output 1kHz max Trigger Rate.

Note 2 for No Dimming Control Connect 0-10V Intensity Control to 24VDC for maximum intensity without control.

See Table 1A: Part Number Key for Cable Part Number by length

TABLE 2: TXBL/TXCBL INTERFACE CABLE WITH AN M12A FEMALE CONNECTOR

| M12A Wiring | | | | | |
|--|-------|----------------------|-------|-------|----------------------|
| Connector #1 | Pin 1 | Pin 2 | Pin 3 | Pin 4 | Pin 5 |
| 1 Wavelength (Note 1) | 24V | Wavelength #1: 0-10V | GND | TRG | NC |
| 2 Wavelengths (Note 1) | 24V | Wavelength #1: 0-10V | GND | TRG | Wavelength #2: 0-10V |
| 3 Wavelengths | 24V | Wavelength #1: 0-10V | GND | TRG | Wavelength #2: 0-10V |
| 4 Wavelengths | 24V | Wavelength #1: 0-10V | GND | TRG | Wavelength #2: 0-10V |
| Connector #2 | | | | | |
| 1 Wavelength (Note 1) | 24V | NC | GND | NC | NC |
| 2 Wavelengths (Note 1) | 24V | NC | GND | NC | NC |
| 3 Wavelengths | 24V | Wavelength #3: 0-10V | GND | NC | NC |
| 4 Wavelengths | 24V | Wavelength #3: 0-10V | GND | NC | Wavelength #4: 0-10V |
| Connector #3 | | | | | |
| All Lights requiring 3 or 4 connectors | 24V | NC | GND | NC | NC |
| Connector #4 | | | | | |
| Not applicable | 24V | NC | GND | NC | NC |

Note 1: Additional Connector may be required. See Table 4: Max Current Draw and Number of Connectors per Size (-DC Version)



M12 4-pin T-Code Bulkhead

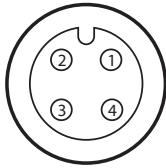
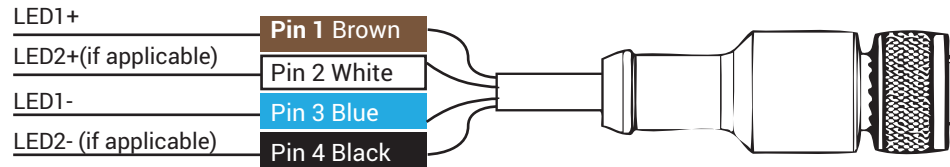

FIGURE 3: CABLE COLOR CODE, M12T CONNECTOR

| Pin | Function | Wire Color |
|-----|-----------------------|------------|
| 1 | LED1+ | Brown |
| 2 | LED2+ (if applicable) | White |
| 3 | LED1- | Blue |
| 4 | LED2- (if applicable) | Black |

FIGURE 4: TXBL INTERFACE CABLE WITH AN M12 4-PIN T-CODE FEMALE CONNECTOR



See Table 1: Part Number Key for Cable Part Number by length.

TABLE 3: TXBL INTERFACE CABLE WITH AN M12 4-PIN T-CODE FEMALE CONNECTOR

| M12T Wiring | | | | |
|---------------|--------|--------|--------|--------|
| Connector #1 | Pin 1 | Pin 2 | Pin 3 | Pin 4 |
| 1 Wavelength | LED 1+ | LED 2+ | LED 1- | LED 2- |
| 2 Wavelengths | LED 1+ | LED 2+ | LED 1- | LED 2- |
| 3 Wavelengths | LED 1+ | LED 2+ | LED 1- | LED 2- |
| 4 Wavelengths | LED 1+ | LED 2+ | LED 1- | LED 2- |
| Connector #2 | | | | |
| 1 Wavelength | | | | |
| 2 Wavelengths | | | | |
| 3 Wavelengths | LED 3+ | NC | LED 3- | NC |
| 4 Wavelengths | LED 3+ | LED 4+ | LED 3- | LED 4- |

ULC-2 CONTROLLER

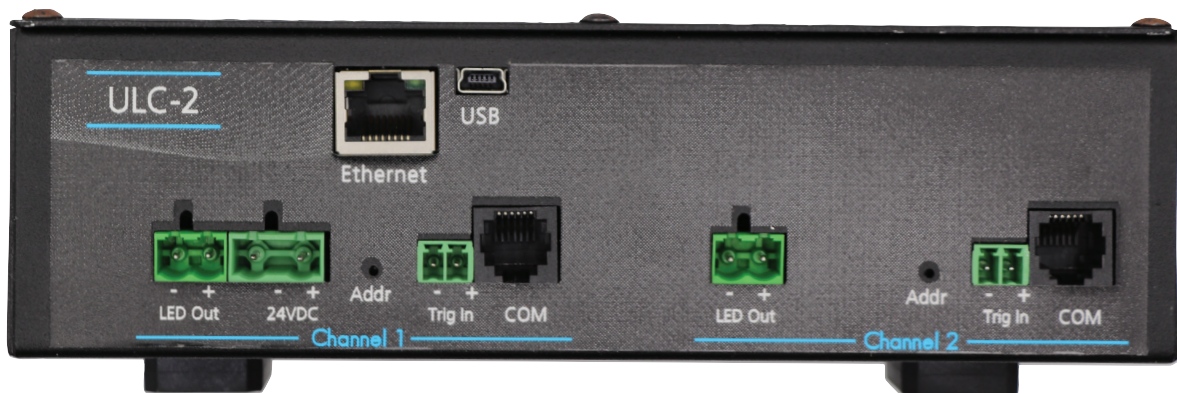



TABLE 4: MAX CURRENT DRAW AND NUMBER OF CONNECTORS PER SIZE (-DC VERSION)

| | | XX | | | | | | | | | | | | | | | |
|------|------|------|------|------|------|------|------|------|------|------|-----|-----|-----|-----|------|--|--|
| TXBL | 02 | 03 | 04 | 05 | 06 | 07 | 08 | 09 | 10 | 11 | 12 | 13 | 14 | 15 | 16 | | |
| 02 | 0.06 | | | | | | | | | | | | | | | | |
| 03 | 0.10 | 0.15 | | | | | | | | | | | | | | | |
| 04 | 0.13 | 0.19 | 0.26 | | | | | | | | | | | | | | |
| 05 | 0.16 | 0.24 | 0.32 | 0.40 | | | | | | | | | | | | | |
| 06 | 0.19 | 0.29 | 0.39 | 0.49 | 0.58 | | | | | | | | | | | | |
| 07 | 0.23 | 0.34 | 0.45 | 0.57 | 0.68 | 0.79 | | | | | | | | | | | |
| 08 | 0.26 | 0.39 | 0.52 | 0.65 | 0.78 | 0.91 | 1.04 | | | | | | | | | | |
| 09 | 0.29 | 0.44 | 0.58 | 0.73 | 0.87 | 1.02 | 1.17 | 1.31 | | | | | | | | | |
| 10 | 0.32 | 0.49 | 0.65 | 0.81 | 0.97 | 1.13 | 1.29 | 1.46 | 1.62 | | | | | | | | |
| 11 | 0.36 | 0.53 | 0.71 | 0.89 | 1.07 | 1.25 | 1.42 | 1.60 | 1.78 | 1.96 | | | | | | | |
| 12 | 0.39 | 0.58 | 0.78 | 0.97 | 1.17 | 1.36 | 1.55 | 1.75 | 1.94 | 2.1 | 2.3 | | | | | | |
| 13 | 0.42 | 0.63 | 0.84 | 1.05 | 1.26 | 1.47 | 1.68 | 1.89 | 2.1 | 2.3 | 2.5 | 2.7 | | | | | |
| 14 | 0.45 | 0.68 | 0.91 | 1.13 | 1.36 | 1.59 | 1.81 | 2.0 | 2.3 | 2.5 | 2.7 | 2.9 | 3.2 | | | | |
| 15 | 0.49 | 0.73 | 0.97 | 1.21 | 1.46 | 1.70 | 1.94 | 2.2 | 2.4 | 2.7 | 2.9 | 3.2 | 3.4 | 3.6 | | | |
| 16 | 0.52 | 0.78 | 1.04 | 1.29 | 1.55 | 1.81 | 2.1 | 2.3 | 2.6 | 2.8 | 3.1 | 3.4 | 3.6 | 3.9 | 4.1 | | |
| 17 | 0.55 | 0.83 | 1.10 | 1.38 | 1.65 | 1.93 | 2.2 | 2.5 | 2.8 | 3.0 | 3.3 | 3.6 | 3.9 | 4.1 | 4.4 | | |
| 18 | 0.58 | 0.87 | 1.17 | 1.46 | 1.75 | 2.0 | 2.3 | 2.6 | 2.9 | 3.2 | 3.5 | 3.8 | 4.1 | 4.4 | 4.7 | | |
| 19 | 0.61 | 0.92 | 1.23 | 1.54 | 1.84 | 2.2 | 2.5 | 2.8 | 3.1 | 3.4 | 3.7 | 4.0 | 4.3 | 4.6 | 4.9 | | |
| 20 | 0.65 | 0.97 | 1.29 | 1.62 | 1.94 | 2.3 | 2.6 | 2.9 | 3.2 | 3.6 | 3.9 | 4.2 | 4.5 | 4.9 | 5.2 | | |
| 21 | 0.68 | 1.02 | 1.36 | 1.70 | 2.0 | 2.4 | 2.7 | 3.1 | 3.4 | 3.7 | 4.1 | 4.4 | 4.8 | 5.1 | 5.4 | | |
| 22 | 0.71 | 1.07 | 1.42 | 1.78 | 2.1 | 2.5 | 2.8 | 3.2 | 3.6 | 3.9 | 4.3 | 4.6 | 5.0 | 5.3 | 5.7 | | |
| 23 | 0.74 | 1.12 | 1.49 | 1.86 | 2.2 | 2.6 | 3.0 | 3.4 | 3.7 | 4.1 | 4.5 | 4.8 | 5.2 | 5.6 | 6.0 | | |
| 24 | 0.78 | 1.17 | 1.55 | 1.94 | 2.3 | 2.7 | 3.1 | 3.5 | 3.9 | 4.3 | 4.7 | 5.0 | 5.4 | 5.8 | 6.2 | | |
| 25 | 0.81 | 1.21 | 1.62 | 2.0 | 2.4 | 2.8 | 3.2 | 3.6 | 4.0 | 4.5 | 4.9 | 5.3 | 5.7 | 6.1 | 6.5 | | |
| 26 | 0.84 | 1.26 | 1.68 | 2.1 | 2.5 | 2.9 | 3.4 | 3.8 | 4.2 | 4.6 | 5.0 | 5.5 | 5.9 | 6.3 | 6.7 | | |
| 27 | 0.87 | 1.31 | 1.75 | 2.2 | 2.6 | 3.1 | 3.5 | 3.9 | 4.4 | 4.8 | 5.2 | 5.7 | 6.1 | 6.6 | 7.0 | | |
| 28 | 0.91 | 1.36 | 1.81 | 2.3 | 2.7 | 3.2 | 3.6 | 4.1 | 4.5 | 5.0 | 5.4 | 5.9 | 6.3 | 6.8 | 7.3 | | |
| 29 | 0.94 | 1.41 | 1.88 | 2.3 | 2.8 | 3.3 | 3.8 | 4.2 | 4.7 | 5.2 | 5.6 | 6.1 | 6.6 | 7.0 | 7.5 | | |
| 30 | 0.97 | 1.46 | 1.94 | 2.4 | 2.9 | 3.4 | 3.9 | 4.4 | 4.9 | 5.3 | 5.8 | 6.3 | 6.8 | 7.3 | 7.8 | | |
| 31 | 1.00 | 1.51 | 2.0 | 2.5 | 3.0 | 3.5 | 4.0 | 4.5 | 5.0 | 5.5 | 6.0 | 6.5 | 7.0 | 7.5 | 8.0 | | |
| 32 | 1.04 | 1.55 | 2.1 | 2.6 | 3.1 | 3.6 | 4.1 | 4.7 | 5.2 | 5.7 | 6.2 | 6.7 | 7.3 | 7.8 | 8.3 | | |
| 33 | 1.07 | 1.60 | 2.1 | 2.7 | 3.2 | 3.7 | 4.3 | 4.8 | 5.3 | 5.9 | 6.4 | 6.9 | 7.5 | 8.0 | 8.5 | | |
| 34 | 1.10 | 1.65 | 2.2 | 2.8 | 3.3 | 3.9 | 4.4 | 5.0 | 5.5 | 6.1 | 6.6 | 7.2 | 7.7 | 8.3 | 8.8 | | |
| 35 | 1.13 | 1.70 | 2.3 | 2.8 | 3.4 | 4.0 | 4.5 | 5.1 | 5.7 | 6.2 | 6.8 | 7.4 | 7.9 | 8.5 | 9.1 | | |
| 36 | 1.17 | 1.75 | 2.3 | 2.9 | 3.5 | 4.1 | 4.7 | 5.2 | 5.8 | 6.4 | 7.0 | 7.6 | 8.2 | 8.7 | 9.3 | | |
| 37 | 1.20 | 1.80 | 2.4 | 3.0 | 3.6 | 4.2 | 4.8 | 5.4 | 6.0 | 6.6 | 7.2 | 7.8 | 8.4 | 9.0 | 9.6 | | |
| 38 | 1.23 | 1.84 | 2.5 | 3.1 | 3.7 | 4.3 | 4.9 | 5.5 | 6.1 | 6.8 | 7.4 | 8.0 | 8.6 | 9.2 | 9.8 | | |
| 39 | 1.26 | 1.89 | 2.5 | 3.2 | 3.8 | 4.4 | 5.0 | 5.7 | 6.3 | 6.9 | 7.6 | 8.2 | 8.8 | 9.5 | 10.1 | | |
| 40 | 1.29 | 1.94 | 2.6 | 3.2 | 3.9 | 4.5 | 5.2 | 5.8 | 6.5 | 7.1 | 7.8 | 8.4 | 9.1 | 9.7 | 10.4 | | |

Example
 Part Number sequence: TXBLXXYY:
 • XX = shortest dimension, YY is ≥ XX
 • One unit of measurement = 25mm of active area: TXBL0816 is 200mm X 400mm active area
 • The TXBL0816 requires a quantity of one (1) M12A connector; Current = 2.1A

Legend
 Requires (1) M12
 Requires (2) M12
 Requires (3) M12



TABLE 5: ULC SETTINGS DC PER CHANNEL (AMPS) PER SIZE

| | | XX | | | | | | | | | | | | | | | |
|------|-----|-----|-----|-----|-----|-----|-----|-----|-----|-----|-----|-----|-----|-----|-----|--|--|
| TXBL | 02 | 03 | 04 | 05 | 06 | 07 | 08 | 09 | 10 | 11 | 12 | 13 | 14 | 15 | 16 | | |
| 02 | 0.1 | | | | | | | | | | | | | | | | |
| 03 | 0.2 | 0.3 | | | | | | | | | | | | | | | |
| 04 | 0.2 | 0.3 | 0.4 | | | | | | | | | | | | | | |
| 05 | 0.3 | 0.4 | 0.6 | 0.7 | | | | | | | | | | | | | |
| 06 | 0.3 | 0.5 | 0.7 | 0.8 | 1.0 | | | | | | | | | | | | |
| 07 | 0.4 | 0.6 | 0.8 | 1.0 | 1.2 | 1.4 | | | | | | | | | | | |
| 08 | 0.4 | 0.7 | 0.9 | 1.1 | 1.3 | 1.6 | 1.8 | | | | | | | | | | |
| 09 | 0.5 | 0.8 | 1.0 | 1.3 | 1.5 | 1.8 | 2.0 | 2.3 | | | | | | | | | |
| 10 | 0.6 | 0.8 | 1.1 | 1.4 | 1.7 | 2.0 | 2.2 | 2.5 | 2.8 | | | | | | | | |
| 11 | 0.6 | 0.9 | 1.2 | 1.5 | 1.8 | 2.2 | 2.5 | 2.8 | 3.1 | 3.4 | | | | | | | |
| 12 | 0.7 | 1.0 | 1.3 | 1.7 | 2.0 | 2.4 | 2.7 | 3.0 | 3.4 | 3.7 | 2.0 | | | | | | |
| 13 | 0.7 | 1.1 | 1.5 | 1.8 | 2.2 | 2.5 | 2.9 | 3.3 | 3.6 | 2.0 | 2.2 | 2.4 | | | | | |
| 14 | 0.8 | 1.2 | 1.6 | 2.0 | 2.4 | 2.7 | 3.1 | 3.5 | 3.9 | 2.2 | 2.4 | 2.5 | 2.7 | | | | |
| 15 | 0.8 | 1.3 | 1.7 | 2.1 | 2.5 | 2.9 | 3.4 | 3.8 | 2.1 | 2.3 | 2.5 | 2.7 | 2.9 | 3.2 | | | |
| 16 | 0.9 | 1.3 | 1.8 | 2.2 | 2.7 | 3.1 | 3.6 | 2.0 | 2.2 | 2.5 | 2.7 | 2.9 | 3.1 | 3.4 | 3.6 | | |
| 17 | 1.0 | 1.4 | 1.9 | 2.4 | 2.9 | 3.3 | 3.8 | 2.1 | 2.4 | 2.6 | 2.9 | 3.1 | 3.3 | 3.6 | 2.5 | | |
| 18 | 1.0 | 1.5 | 2.0 | 2.5 | 3.0 | 3.5 | 2.0 | 2.3 | 2.5 | 2.8 | 3.0 | 3.3 | 3.5 | 2.5 | 2.7 | | |
| 19 | 1.1 | 1.6 | 2.1 | 2.7 | 3.2 | 3.7 | 2.1 | 2.4 | 2.7 | 2.9 | 3.2 | 3.5 | 2.5 | 2.7 | 2.8 | | |
| 20 | 1.1 | 1.7 | 2.2 | 2.8 | 3.4 | 3.9 | 2.2 | 2.5 | 2.8 | 3.1 | 3.4 | 2.4 | 2.6 | 2.8 | 3.0 | | |
| 21 | 1.2 | 1.8 | 2.4 | 2.9 | 3.5 | 2.1 | 2.4 | 2.6 | 2.9 | 3.2 | 3.5 | 2.5 | 2.7 | 2.9 | 3.1 | | |
| 22 | 1.2 | 1.8 | 2.5 | 3.1 | 3.7 | 2.2 | 2.5 | 2.8 | 3.1 | 3.4 | 2.5 | 2.7 | 2.9 | 3.1 | 3.3 | | |
| 23 | 1.3 | 1.9 | 2.6 | 3.2 | 3.9 | 2.3 | 2.6 | 2.9 | 3.2 | 3.5 | 2.6 | 2.8 | 3.0 | 3.2 | 3.4 | | |
| 24 | 1.3 | 2.0 | 2.7 | 3.4 | 2.0 | 2.4 | 2.7 | 3.0 | 3.4 | 2.5 | 2.7 | 2.9 | 3.1 | 3.4 | 3.6 | | |
| 25 | 1.4 | 2.1 | 2.8 | 3.5 | 2.1 | 2.5 | 2.8 | 3.2 | 3.5 | 2.6 | 2.8 | 3.0 | 3.3 | 3.5 | 3.7 | | |
| 26 | 1.5 | 2.2 | 2.9 | 3.6 | 2.2 | 2.5 | 2.9 | 3.3 | 2.4 | 2.7 | 2.9 | 3.2 | 3.4 | 3.6 | 3.9 | | |
| 27 | 1.5 | 2.3 | 3.0 | 3.8 | 2.3 | 2.6 | 3.0 | 3.4 | 2.5 | 2.8 | 3.0 | 3.3 | 3.5 | 3.8 | 3.0 | | |
| 28 | 1.6 | 2.4 | 3.1 | 3.9 | 2.4 | 2.7 | 3.1 | 3.5 | 2.6 | 2.9 | 3.1 | 3.4 | 3.7 | 3.9 | 3.1 | | |
| 29 | 1.6 | 2.4 | 3.2 | 2.0 | 2.4 | 2.8 | 3.2 | 3.7 | 2.7 | 3.0 | 3.2 | 3.5 | 3.8 | 3.0 | 3.2 | | |
| 30 | 1.7 | 2.5 | 3.4 | 2.1 | 2.5 | 2.9 | 3.4 | 2.5 | 2.8 | 3.1 | 3.4 | 3.6 | 3.9 | 3.2 | 3.4 | | |
| 31 | 1.7 | 2.6 | 3.5 | 2.2 | 2.6 | 3.0 | 3.5 | 2.6 | 2.9 | 3.2 | 3.5 | 3.8 | 3.0 | 3.3 | 3.5 | | |
| 32 | 1.8 | 2.7 | 3.6 | 2.2 | 2.7 | 3.1 | 3.6 | 2.7 | 3.0 | 3.3 | 3.6 | 3.9 | 3.1 | 3.4 | 3.6 | | |
| 33 | 1.8 | 2.8 | 3.7 | 2.3 | 2.8 | 3.2 | 2.5 | 2.8 | 3.1 | 3.4 | 3.7 | 3.0 | 3.2 | 3.5 | 3.7 | | |
| 34 | 1.9 | 2.9 | 3.8 | 2.4 | 2.9 | 3.3 | 2.5 | 2.9 | 3.2 | 3.5 | 3.8 | 3.1 | 3.3 | 3.6 | 3.8 | | |
| 35 | 2.0 | 2.9 | 3.9 | 2.5 | 2.9 | 3.4 | 2.6 | 2.9 | 3.3 | 3.6 | 3.9 | 3.2 | 3.4 | 2.9 | 3.9 | | |
| 36 | 2.0 | 3.0 | 2.0 | 2.5 | 3.0 | 3.5 | 2.7 | 3.0 | 3.4 | 3.7 | 3.0 | 3.3 | 3.5 | 3.0 | 3.2 | | |
| 37 | 2.1 | 3.1 | 2.1 | 2.6 | 3.1 | 3.6 | 2.8 | 3.1 | 3.5 | 3.8 | 3.1 | 3.4 | 3.6 | 3.1 | 3.3 | | |
| 38 | 2.1 | 3.2 | 2.1 | 2.7 | 3.2 | 2.5 | 2.8 | 3.2 | 3.5 | 3.9 | 3.2 | 3.5 | 3.0 | 3.2 | 3.4 | | |
| 39 | 2.2 | 3.3 | 2.2 | 2.7 | 3.3 | 2.5 | 2.9 | 3.3 | 3.6 | 3.0 | 3.3 | 3.5 | 3.1 | 3.3 | 3.5 | | |
| 40 | 2.2 | 3.4 | 2.2 | 2.8 | 3.4 | 2.6 | 3.0 | 3.4 | 3.7 | 3.1 | 3.4 | 2.9 | 3.1 | 3.4 | 3.6 | | |

Example
 Part Number sequence: TXBLXXYY:
 • XX = shortest dimension, YY is ≥ XX.
 • One unit of measurement = 25mm of active area, example: TXBL0513 is 125mm X 325mm active area
 • For the TXBL0513, the ULC-2 setting is 1.8A maximum
 Note: Color on chart corresponds to number of ULC channels needed AND number of M12 connectors needed.

Legend

| |
|--|
| Requires (1) ULC chan (on 1 M12 connector) |
| Requires (2) ULC chan (on 1 M12 connector) |
| Requires (3) ULC chan (on 2 M12 connector) |
| Requires (4) ULC chan (on 2 M12 connector) |
| Requires (5) ULC chan (on 3 M12 connector) |

ULC STROBE SETTINGS

- Max overdriving pulse duration= 1000µs (1ms)
- For trigger duty cycles >= 5%
- For ULC-2 external controller, max strobe current per ULC-2 channel is 40A

Single channel ULC Strobing current = TXBLXX * TXBLYY * .028 / User-Desired Trigger Input Duty Cycle / number of colors in light

Examples:

- TXBL0508-W-U and customer desired duty cycle of 20% -- ULC Strobing current = 05 * 08 * .028 / .2 / 1 = 5.6A
- TXCBL0202-R-U and customer desired duty cycle of 5% -- ULC Strobing current = 02 * 02 * .028 / .05 / 1 = 2.2A
- TXCBL1212-B-U and customer desired duty cycle of 10% -- ULC Strobing current = 11 * 12 * .028 / .1 / 1 = 37A
- TXBL1624-RGB-U and customer desired duty cycle of 10% -- ULC Strobing current = 16 * 24 * .028 / .1 / 3 = 35.8A for each of (3) ULC channels

YY

TXBL/ TXCBL Weight vs. Area

TX Series
Back Light

TABLE 6: WEIGHT (KG) FOR ACTIVE AREA WIDTH AND LENGTH

| | | XX | | | | | | | | | | | | | | | |
|------|-----|-----|-----|-----|-----|-----|-----|-----|-----|-----|-----|-----|-----|-----|-----|--|--|
| TXBL | 02 | 03 | 04 | 05 | 06 | 07 | 08 | 09 | 10 | 11 | 12 | 13 | 14 | 15 | 16 | | |
| 02 | 0.2 | | | | | | | | | | | | | | | | |
| 03 | 0.3 | 0.3 | | | | | | | | | | | | | | | |
| 04 | 0.3 | 0.3 | 0.4 | | | | | | | | | | | | | | |
| 05 | 0.3 | 0.4 | 0.4 | 0.5 | | | | | | | | | | | | | |
| 06 | 0.4 | 0.4 | 0.5 | 0.6 | 0.6 | | | | | | | | | | | | |
| 07 | 0.4 | 0.5 | 0.5 | 0.6 | 0.7 | 0.8 | | | | | | | | | | | |
| 08 | 0.4 | 0.5 | 0.6 | 0.7 | 0.8 | 0.8 | 0.9 | | | | | | | | | | |
| 09 | 0.5 | 0.6 | 0.6 | 0.7 | 0.8 | 0.9 | 1.0 | 1.1 | | | | | | | | | |
| 10 | 0.5 | 0.6 | 0.7 | 0.8 | 0.9 | 1.0 | 1.1 | 1.2 | 1.3 | | | | | | | | |
| 11 | 0.5 | 0.6 | 0.7 | 0.9 | 1.0 | 1.1 | 1.2 | 1.3 | 1.4 | 1.5 | | | | | | | |
| 12 | 0.6 | 0.7 | 0.8 | 0.9 | 1.0 | 1.1 | 1.3 | 1.4 | 1.5 | 1.6 | 1.7 | | | | | | |
| 13 | 0.6 | 0.7 | 0.8 | 1.0 | 1.1 | 1.2 | 1.3 | 1.5 | 1.6 | 1.7 | 1.8 | 2.0 | | | | | |
| 14 | 0.6 | 0.8 | 0.9 | 1.0 | 1.2 | 1.3 | 1.4 | 1.6 | 1.7 | 1.8 | 1.9 | 2.1 | 2.2 | | | | |
| 15 | 0.7 | 0.8 | 0.9 | 1.1 | 1.2 | 1.4 | 1.5 | 1.6 | 1.8 | 1.9 | 2.1 | 2.2 | 2.3 | 2.5 | | | |
| 16 | 0.7 | 0.8 | 1.0 | 1.1 | 1.3 | 1.4 | 1.6 | 1.7 | 1.9 | 2.0 | 2.2 | 2.3 | 2.5 | 2.6 | 2.8 | | |
| 17 | 0.7 | 0.9 | 1.1 | 1.2 | 1.4 | 1.5 | 1.7 | 1.8 | 2.0 | 2.2 | 2.3 | 2.5 | 2.6 | 2.8 | 3.0 | | |
| 18 | 0.8 | 0.9 | 1.1 | 1.3 | 1.4 | 1.6 | 1.8 | 1.9 | 2.1 | 2.3 | 2.4 | 2.6 | 2.8 | 2.9 | 3.1 | | |
| 19 | 0.8 | 1.0 | 1.2 | 1.3 | 1.5 | 1.7 | 1.9 | 2.0 | 2.2 | 2.4 | 2.6 | 2.7 | 2.9 | 3.1 | 3.3 | | |
| 20 | 0.8 | 1.0 | 1.2 | 1.4 | 1.6 | 1.8 | 1.9 | 2.1 | 2.3 | 2.5 | 2.7 | 2.9 | 3.0 | 3.2 | 3.4 | | |
| 21 | 0.9 | 1.1 | 1.3 | 1.4 | 1.6 | 1.8 | 2.0 | 2.2 | 2.4 | 2.6 | 2.8 | 3.0 | 3.2 | 3.4 | 3.5 | | |
| 22 | 0.9 | 1.1 | 1.3 | 1.5 | 1.7 | 1.9 | 2.1 | 2.3 | 2.5 | 2.7 | 2.9 | 3.1 | 3.3 | 3.5 | 3.7 | | |
| 23 | 0.9 | 1.1 | 1.4 | 1.6 | 1.8 | 2.0 | 2.2 | 2.4 | 2.6 | 2.8 | 3.0 | 3.2 | 3.4 | 3.6 | 3.8 | | |
| 24 | 1.0 | 1.2 | 1.4 | 1.6 | 1.8 | 2.0 | 2.3 | 2.5 | 2.7 | 2.9 | 3.1 | 3.3 | 3.6 | 3.8 | 4.0 | | |
| 25 | 1.0 | 1.2 | 1.5 | 1.7 | 1.9 | 2.1 | 2.3 | 2.6 | 2.8 | 3.0 | 3.2 | 3.5 | 3.7 | 3.9 | 4.1 | | |
| 26 | 1.0 | 1.3 | 1.5 | 1.7 | 2.0 | 2.2 | 2.4 | 2.7 | 2.9 | 3.1 | 3.4 | 3.6 | 3.8 | 4.1 | 4.3 | | |
| 27 | 1.1 | 1.3 | 1.6 | 1.8 | 2.0 | 2.3 | 2.5 | 2.8 | 3.0 | 3.2 | 3.5 | 3.7 | 4.0 | 4.2 | 4.4 | | |
| 28 | 1.1 | 1.4 | 1.6 | 1.8 | 2.1 | 2.3 | 2.6 | 2.8 | 3.1 | 3.3 | 3.6 | 3.8 | 4.1 | 4.3 | 4.6 | | |
| 29 | 1.1 | 1.4 | 1.6 | 1.9 | 2.2 | 2.4 | 2.7 | 2.9 | 3.2 | 3.5 | 3.7 | 4.0 | 4.2 | 4.5 | 4.7 | | |
| 30 | 1.2 | 1.4 | 1.7 | 2.0 | 2.2 | 2.5 | 2.8 | 3.0 | 3.3 | 3.6 | 3.8 | 4.1 | 4.4 | 4.6 | 4.9 | | |
| 31 | 1.2 | 1.5 | 1.7 | 2.0 | 2.3 | 2.6 | 2.8 | 3.1 | 3.4 | 3.7 | 3.9 | 4.2 | 4.5 | 4.8 | 5.0 | | |
| 32 | 1.2 | 1.5 | 1.8 | 2.1 | 2.4 | 2.6 | 2.9 | 3.2 | 3.5 | 3.8 | 4.1 | 4.3 | 4.6 | 4.9 | 5.2 | | |
| 33 | 1.3 | 1.6 | 1.8 | 2.1 | 2.4 | 2.7 | 3.0 | 3.3 | 3.6 | 3.9 | 4.2 | 4.5 | 4.7 | 5.0 | 5.3 | | |
| 34 | 1.3 | 1.6 | 1.9 | 2.2 | 2.5 | 2.8 | 3.1 | 3.4 | 3.7 | 4.0 | 4.3 | 4.6 | 4.9 | 5.2 | 5.5 | | |
| 35 | 1.3 | 1.6 | 1.9 | 2.3 | 2.6 | 2.9 | 3.2 | 3.5 | 3.8 | 4.1 | 4.4 | 4.7 | 5.0 | 5.3 | 5.6 | | |
| 36 | 1.4 | 1.7 | 2.0 | 2.3 | 2.6 | 2.9 | 3.3 | 3.6 | 3.9 | 4.2 | 4.5 | 4.8 | 5.1 | 5.5 | 5.8 | | |
| 37 | 1.4 | 1.7 | 2.0 | 2.4 | 2.7 | 3.0 | 3.3 | 3.7 | 4.0 | 4.3 | 4.6 | 5.0 | 5.3 | 5.6 | 5.9 | | |
| 38 | 1.4 | 1.8 | 2.1 | 2.4 | 2.8 | 3.1 | 3.4 | 3.8 | 4.1 | 4.4 | 4.7 | 5.1 | 5.4 | 5.7 | 6.1 | | |
| 39 | 1.5 | 1.8 | 2.1 | 2.5 | 2.8 | 3.2 | 3.5 | 3.8 | 4.2 | 4.5 | 4.9 | 5.2 | 5.5 | 5.9 | 6.2 | | |
| 40 | 1.5 | 1.9 | 2.2 | 2.5 | 2.9 | 3.2 | 3.6 | 3.9 | 4.3 | 4.6 | 5.0 | 5.3 | 5.7 | 6.0 | 6.4 | | |

Part Number sequence:

TXBLXXYY

• XX = shortest dimension,

• YY is \geq XX• One unit of measurement = 25mm
of active area.

Example Active area/weight:

• TXBL0816 = (08) *25mm X (16)

*25mm = 200x400mm,

weight is 1.6 kg.

YY



FIGURE 5:
RELATIVE INTENSITY - WHITE SPECTRAL DATA

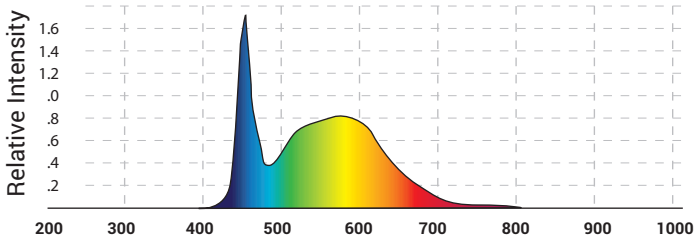

FIGURE 6:
RELATIVE INTENSITY - RED SPECTRAL DATA

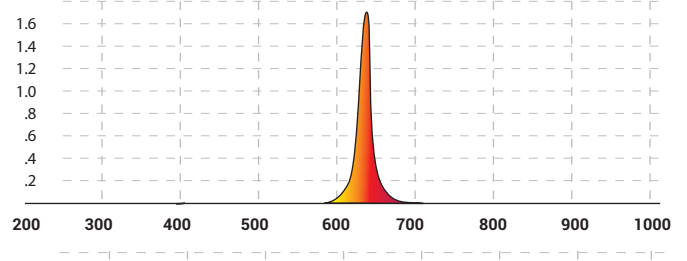

FIGURE 7:
RELATIVE INTENSITY - GREEN SPECTRAL DATA

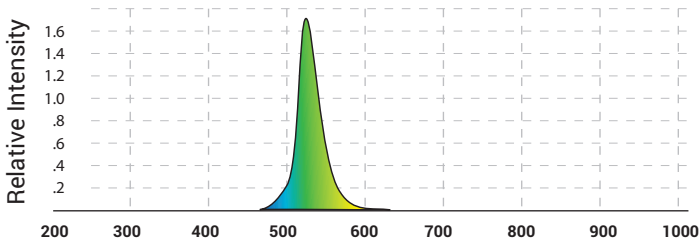

FIGURE 8:
RELATIVE INTENSITY - BLUE SPECTRAL DATA

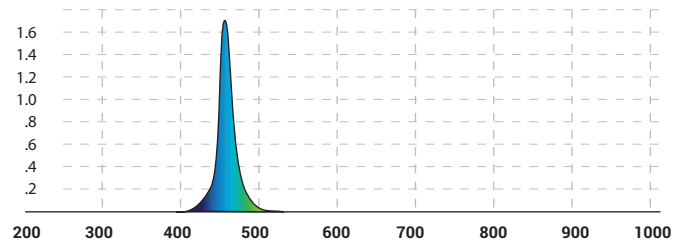

FIGURE 9:
RELATIVE INTENSITY - IR850 SPECTRAL DATA

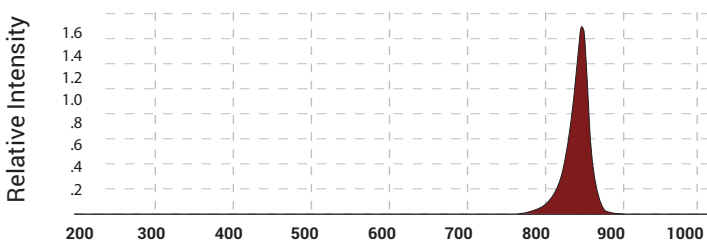

FIGURE 10:
RELATIVE INTENSITY - IR940 SPECTRAL DATA

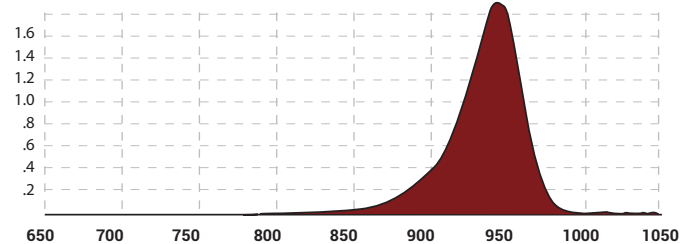

FIGURE 11:
TXBL UNIFORMITY PROFILE



Intensity = 86,000 Lux (263W/m²)

TXBL/ TXCBL Mechanical Drawings



TX Series
Back Light



FIGURE 12: TXBL/ TXCBL DIMENSIONS TOP VIEW

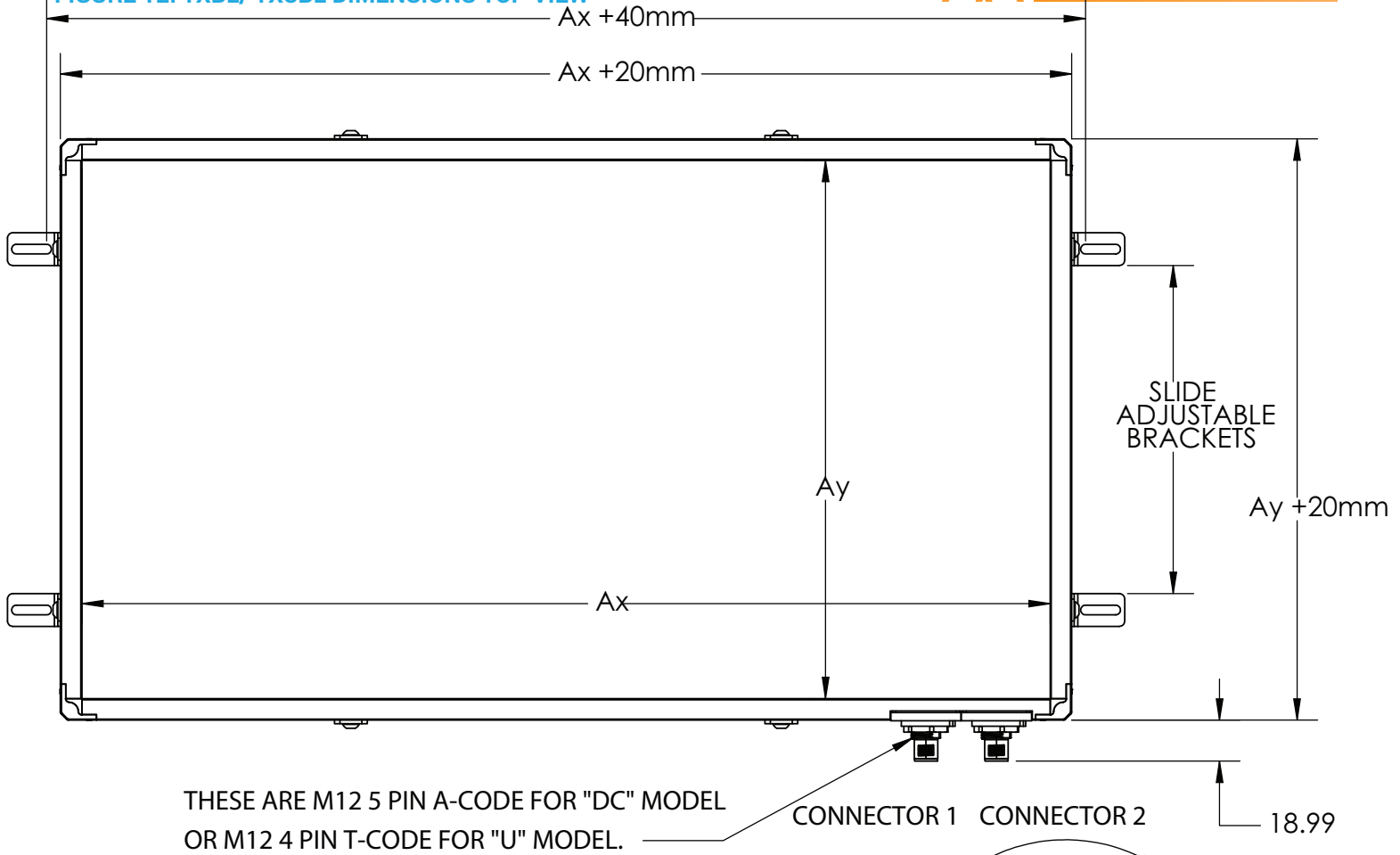
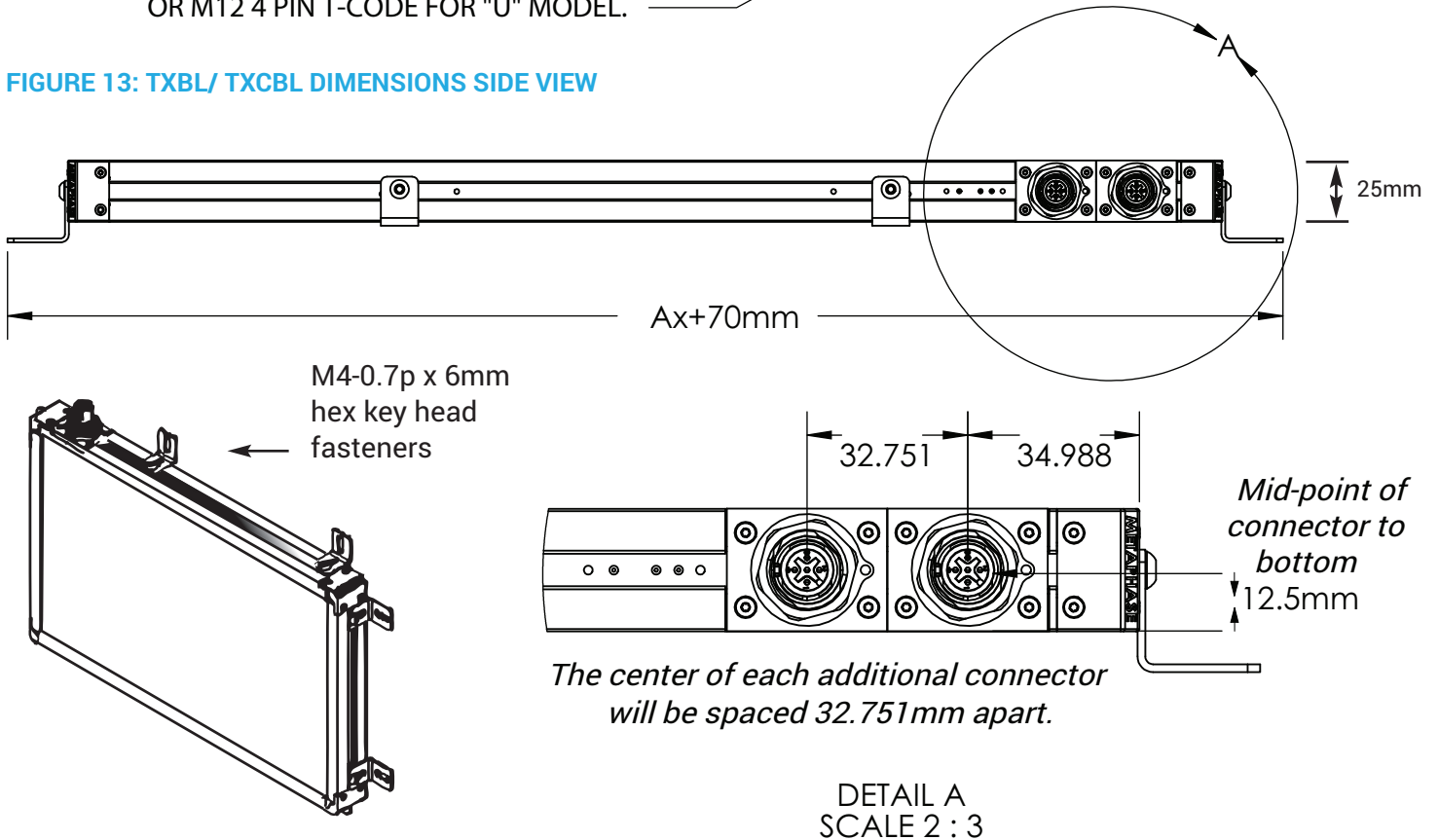

FIGURE 13: TXBL/ TXCBL DIMENSIONS SIDE VIEW





For nearly two decades, Metaphase Technologies has been developing products that implement “The Quality of Light” through engineering and manufacture of cutting-edge LED illuminators for machine vision, military, and specialty lighting applications.

We're proud of our demonstrated expertise engineering flexible lighting solutions that have facilitated integration into thousands of vision systems designs.

Throughout the world, Metaphase clients enjoy the enhanced automation and image capture benefits of our patent-pending breakthroughs in uniform diffuse high brightness and ultra-brightness LED illumination.

First to implement built-in constant current drivers across multiple product lines, Metaphase continues to synergize cutting-edge LED lighting & control technologies that streamline innovation and increases return on investment.

Made in the USA for nearly 30 years, our versatile designs are continuously updated to incorporate the latest advances in LEDs, thermal management, optics, and electronic technologies to meet the challenging needs of today's global automation and scientific marketplace.

Contact us to see how Metaphase can help with your cutting-edge lighting needs.



200 Rittenhouse Circle, West Unit 7, Bristol, PA 19007 USA
+1-215-639-8699 www.metaphase-tech.com